

CECW-EG Engineer Manual 1110-2-2301	Department of the Army U.S. Army Corps of Engineers Washington, DC 20314-1000	EM 1110-2-2301 30 September 1994
	Engineering and Design TEST QUARRIES AND TEST FILLS	
	Distribution Restriction Statement Approved for public release; distribution is unlimited.	

**DEPARTMENT OF THE ARMY
U. S. Army Corps of Engineers
Washington, D.C. 20314-1000**

EM 1110-2-2301

CECW-EG

Manual
No. 1110-2-2301

30 September 1994

**Engineering and Design
TEST QUARRIES AND TEST FILLS**

1. Purpose. This manual establishes criteria and provides guidance for the investigations preceding test quarries, for the development of test quarries, and for the planning and conduct of compacted test-fill programs at civil works projects.

2. Applicability. The provisions of this manual are applicable to all HQUSACE elements, major subordinate commands, districts, laboratories, and field operating activities having civil works responsibilities.

FOR THE COMMANDER:

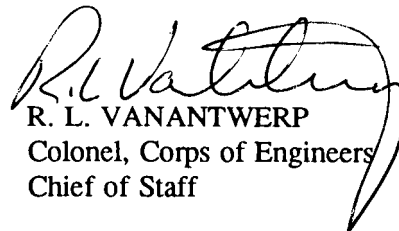
R. L. VANANTWERP
Colonel, Corps of Engineers
Chief of Staff

CECW-EG

Manual
No. 1110-2-2301

30 September 1994

**Engineering and Design
TEST QUARRIES AND TEST FILLS**

Table of Contents

Subject	Paragraph	Page	Subject	Paragraph	Page
Chapter 1			Geophysical Investigations	4-3	4-1
Introduction			Subsurface Explorations	4-4	4-1
Purpose	1-1	1-1	Chapter 5		
Applicability	1-2	1-1	Laboratory Testing		
References	1-3	1-1	General	5-1	5-1
Scope	1-4	1-1	Petrographic Examination	5-2	5-1
General Considerations	1-5	1-1	Weight/Volume Properties	5-3	5-1
Test Quarry Justification	1-6	1-1	Strength Tests	5-4	5-1
PART 1			Rock Durability Tests	5-5	5-1
Test Quarries			Chapter 6		
Chapter 2			Location and Design of Test Quarries		
Investigation Stages			General	6-1	6-1
Project Development Phases and Associated Geotechnical Investigations	2-1	2-1	Evaluation of Project Rock Production Requirements	6-2	6-1
Reconnaissance Study Phase	2-2	2-1	Evaluation of Potential Test Quarry Sites	6-3	6-1
Feasibility Study Phase	2-3	2-1	Test Quarry Layouts	6-4	6-2
Preconstruction Engineering and Design Phase	2-4	2-1	Gradation Measurements	6-5	6-9
Construction Phase	2-5	2-1	Deterioration and Incipient Fracture Examination	6-6	6-12
Operations Phase	2-6	2-2	Rock Processing	6-7	6-13
Chapter 3			Chapter 7		
Regional Investigations and Site Reconnaissance			Test Quarry Operations		
General	3-1	3-1	Supervision	7-1	7-1
Initial Regional Geology Studies	3-2	3-1	Safety Considerations	7-2	7-1
Field Reconnaissance	3-3	3-1	Modification of Design	7-3	7-1
Survey of Existing Excavations	3-4	3-1	Blasting Plans	7-4	7-1
Chapter 4			Slope Mapping and Presplitting Observations	7-5	7-2
Field Investigations			Rock Quality and Pre-Test Fill Gradations	7-6	7-3
General	4-1	4-1			
Geologic Mapping	4-2	4-1			

Subject	Paragraph	Page
Rock Processing Results	7-7	7-3
Report	7-8	7-4

**PART 2
TEST FILLS**

**Chapter 8
General Considerations**

Background	8-1	8-1
Why a Test Fill?	8-2	8-1
Representative Procedures	8-3	8-3
Test-Fill Scheduling	8-4	8-3
Flexibility	8-5	8-3

**Chapter 9
Planning and Design**

General	9-1	9-1
Location of the Test Fill	9-2	9-1
Geometry	9-3	9-1
Test Sections or Lanes	9-4	9-1
Equipment	9-5	9-2

**Chapter 10
Test Fill Construction**

Foundation Preparation	10-1	10-1
Placement of Hard to Medium Rock	10-2	10-1
Placement of Soft Rock	10-3	10-4
Rockfill Versus Soil	10-4	10-5
Use of Water	10-5	10-5
Compaction and Compaction Equipment	10-6	10-6

Subject	Paragraph	Page
---------	-----------	------

**Chapter 11
Measurements and Observations**

General	11-1	11-1
Densification	11-2	11-1
Gradation Tests	11-3	11-4
Percolation Tests	11-4	11-5
Other Tests	11-5	11-9
Visual Observations	11-6	11-10
Inspection Trenches or Pits	11-7	11-10

**Chapter 12
Evaluation of Test Fill Results**

General	12-1	12-1
Settlement Data	12-2	12-1
Roller Passes	12-3	12-1
Gradation Data	12-4	12-1
In Situ Density Data	12-5	12-1
Inspection Trench	12-6	12-5
Test Fill Report	12-7	12-9

**Appendix A
References**

**Appendix B
Vibratory Roller Information**

**Appendix C
List of Symbols**

Chapter 1 Introduction

1-1. Purpose

This manual establishes criteria and provides guidance for the investigations preceding test quarries, for the development of test quarries, and for the planning and conduct of compacted test-fill programs at civil works projects.

1-2. Applicability

The provisions of this manual are applicable to all HQUSACE elements, major subordinate commands, districts, laboratories, and field operating activities having civil works responsibilities.

1-3. References

Appendix A contains a list of required and related publications pertaining to this manual. Unless otherwise noted, all references are available on interlibrary loan from the Research Library, ATTN: CEWES-IM-MI-R, U.S. Army Engineer Waterways Experiment Station, 3909 Halls Ferry Road, Vicksburg, MS 39180-6199.

1-4. Scope

This manual is intended to be a guide for use in planning the portions of the project geotechnical investigations dealing with rock source materials, the design and operation of a test quarry, and the design and conduct of a rock test fill program. This manual is not intended to be a textbook on engineering geology, blasting or rock excavation, or the many possible variations and elements of a test fill program. Actual investigations, test quarry design and development, and test-fill specifics must, in all instances, be tailored to individual project requirements. While the focus of the manual is upon determining the means to produce, place, and compact rock fill materials, the portions concerning test quarries are also applicable to establishing sources for other rock uses such as riprap or concrete aggregate. Part 1 of the manual will address test quarries and Part 2 will treat compacted rock test fills.

1-5. General Considerations

An integral part of the development of large civil works projects is the establishment of sources of material for embankment or fill construction. Many water-retention and water-conveyance projects require large volumes of rock material. As a consequence, the selection of the

project site and the selection of the types of project components frequently involve the type and availability of soil and rock materials. Test quarries are especially important where there are questions about the suitability and behavior of rock in required excavations for use in embankment rockfill zones, for slope protection or (less frequently) for concrete aggregate sources. Even experienced practitioners often cannot predict how rock obtained from an excavation or quarry will break down upon blasting and excavation or subsequently upon transport, placement, and compaction in a fill operation. The most frequent trouble has occurred when the quarried material either contained more fines or more oversized material or degraded more in transport, placement, and compaction than had been anticipated in the design. It has sometimes been necessary to make major design changes because rock behavior was contrary to that anticipated by the designers (EM 1110-2-1911). The use of test quarries and associated test fills has assisted in precluding such expensive surprises. In addition to providing the rock materials for test fills, test quarries have also provided the following information for project design:

- a. Cut slope design constraints resulting from geologic structural details.
- b. Blasting patterns and loading and resulting rock fragmentation.
- c. Suitability of quarry-run rock.
- d. Required rock processing methods.

On many projects, the results of quarry tests have also aided prospective bidders with a much better understanding of required excavation methods and rock drilling and blasting characteristics. The slope development aspects of the test quarry development (presplitting panels and production blast stand-off distances) and geologic maps of the test quarry slopes have aided in the design of required excavation slopes. Because of the time and cost associated with rock test quarries and test fills, it is imperative that they be carefully designed and conducted to yield good, useful data for the design.

1-6. Test Quarry Justification

A test quarry is not justified under all circumstances. Before recommending that a test quarry program be initiated, certain questions should be carefully considered to determine if a test quarry can improve design, reduce the probability of differing site conditions claims and save money during construction. If most of the following

EM 1110-2-2301
30 Sep 94

questions are answered in the affirmative, a test quarry program is probably justified.

a. Is the quantity of stone required for construction enough to merit the cost of developing a test quarry?

b. Are the project design and rock types to be exploited so unique that the necessary stone product information is not available from other projects?

c. Are there questions with regard to the project being considered which are peculiar to that project and

can only be answered with a test quarry?

d. Is a rock test fill required which can only be constructed with rock obtained from a test quarry?

e. Are there reasons to suspect the durability and/or handling characteristics of the rock product which make it important to evaluate with a test quarry?

PART 1
TEST QUARRIES

Chapter 2 Investigation Stages

2-1. Project Development Phases and Associated Geotechnical Investigations

Table 2-1 shows civil works project development phases and the geotechnical investigations performed during these phases.

ER 1110-2-1150 provides the requirements for each of the project development phases and EM 1110-1-1804 provides detailed discussions of the scope of geotechnical investigations for each phase.

2-2. Reconnaissance Study Phase

A reconnaissance study is fully Federally funded and is conducted to determine whether a problem has solutions acceptable to local interests which are in accordance with administration policy and if planning should proceed to the feasibility phase. The reconnaissance phase is general in scope and the engineering effort should be assessing potential alternatives, preparing and reviewing proposed project plans and developing preliminary cost estimates. Detailed engineering analyses are generally not required at this time. The level of engineering effort required for the following feasibility phase is identified and its associated costs estimated. Regional geologic and soils studies and field reconnaissances should be performed. In addition, an initial assessment of the hazardous and toxic waste (HTRW) potential of the study area shall be conducted during the reconnaissance phase as outlined in ER 1165-2-132. The reconnaissance is limited to 12 months.

2-3. Feasibility Study Phase

The feasibility study investigates and recommends solutions to water resource problems and, except for single-purpose inland navigation projects, are cost shared with a non-Federal sponsor. The feasibility study is the basis for Congressional authorization. Sufficient engineering and design should be performed to enable refinement of project features, prepare a baseline cost estimate, develop a design and construction schedule, and allow detailed design on the selected plan to begin immediately upon receipt of preconstruction engineering and design funds. Typical feasibility studies are completed in 3 to 4 years. General Design Memoranda (GDM) are not generally

scheduled or planned. The geotechnical investigation program should assure that sufficient geologic and soils information are acquired and analyzed to verify the project plan, support site selection, selection of structures, assessment of foundation conditions, foundation design and selection of types of foundation treatment. Explorations should be in sufficient detail to support project design and the baseline cost estimate. Potential sources of concrete aggregate, earth and rock borrow, and slope protection material should be located and the investigations necessary to prove-out and develop these sources identified. If needed, further HTRW assessments are conducted during the feasibility study phase as outlined in ER 1165-2-132.

2-4. Preconstruction Engineering and Design Phase

The preconstruction engineering and design phase (PED) is an intensive effort which ends with the preparation of the plans and specifications (P&S) and the award of the first construction contract. PED costs are shared in the same percentage as the purpose of the project. Necessary design memoranda (DM) are prepared and P&S are prepared for the first contract. Geotechnical investigations should be project feature specific and should validate and refine designs and costs developed during the feasibility study. Final investigations in support of development of the test quarry and conduct of the test fill should be completed. If the test quarry and test fill programs are to be accomplished by hired labor, or as contract explorations, they may be accomplished during the PED. If they are to be accomplished by construction contract, P&S should be prepared. The PED phase generally requires about 2 years. HTRW activities, if any, during the PED phase shall follow the procedures outlined in ER 1165-2-132.

2-5. Construction Phase

Engineering effort during the construction phase includes final design efforts, preparation of remaining DM's and preparation of P&S for subsequent construction contracts, site visits, initiation of any foundation report, development of Operation and Maintenance (O&M) manuals and emergency action plans and preparation of as-built drawings. In multi-contract projects, test quarry and test fill development may be accomplished at the beginning of the construction phase. HTRW activities, if any, during construction, shall follow the procedures outlined in ER 1165-2-132.

Table 2-1
Sequence of Geotechnical Investigations with Project Development Phases

Civil Works Project Development Phases	Geotechnical Investigations
Reconnaissance Phase	Development of Regional Geology and Field Reconnaissance
Feasibility Phase	Site Selection and Initial Field Investigations
Preconstruction, Engineering, and Design Phase	Foundation and Design Investigations and Constructibility Review
Construction Phase	Quality Assurance and Post-Construction Documentation Activities
Operation and Maintenance Phase	Special Investigations as required

(Adapted from ER 1110-2-1150 and EM 1110-1-1804)

2-6. Operations Phase

Engineering activities during the operations phase generally consist of the participation in periodic inspections and design and P&S preparation for major repair and rehabilitation projects.

Chapter 3 Regional Investigations and Site Reconnaissance

3-1. General

Regional geologic and site reconnaissance investigations are made to develop the overall project geology and to scope early site investigations. The required investigation steps are shown in Figure 3-1. Detailed guidance on the conduct of these investigations is contained in EM 1110-1-1804. Additional guidance specific to determining the probable need for a test quarry, development of potential test quarry locations, and definition of necessary site investigations is provided in the following paragraphs.

3-2. Initial Regional Geology Studies

The overall regional geologic model resulting from inter-agency coordination, literature surveys, and map and remote sensing studies will assist in the decisions concerning the most efficient and economical project components and their tentative siting. As this project formulation proceeds, the potential need, or lack thereof, for produced rock materials will develop. During the coordination and information survey stages, information can be sought concerning existing sources of rock material in the region. On-line computer aided information retrieval services are readily accessible and can provide detailed reference lists. Information on regional and local geology, etc., relevant to site selection and design may be available from the U.S. Geological Survey. The U.S. Bureau of Reclamation maintains data on their project quarries as a function of broad rock genesis. Additional information on data sources is contained in EM 1110-1-1804. As part of the development of the geology of the region, special attention should be paid to the existence of regional stress fields in terms of how they may affect potential quarry excavations and produced rock products. In addition to determining groundwater conditions for normal project purposes, their effect on potential quarry excavations should be assessed.

3-3. Field Reconnaissance

Field reconnaissance should be made concurrent with, or immediately following the regional geologic studies. While the field reconnaissance stage does not include detailed studies such as geologic mapping, there are a number of observations that can be made that will assist in the decision to employ test quarry programs and in the probable quality of rock fill material that would be produced. Rock types, as noted from existing geologic maps, literature, and remote sensing studies can be confirmed. Tentative depths of overburden and weathered rock can be established. Outcrop observations can provide preliminary information on geologic structure and fracture frequency. Terrain conditions as they relate to tentatively selected required excavations can be determined. From the information obtained during the field reconnaissances, preliminary test quarry layouts can be developed, blasted rock gradations and relative amounts of rock waste can be predicted, follow-on investigations planned and program costs can be estimated.

3-4. Survey of Existing Excavations

As part of the field reconnaissances, or as a separate activity, known existing rock quarries and underground excavations, such as mines and tunnels should be visited and assessed. The USAEWES (1988) Technical Memorandum 6-370 provides information on, and test data from, quarries in the local area. Information can be obtained on lithology, structure, and fabric for the same or rock types similar to those at the tentative project locations. Information on produced rock gradations and amounts of rock waste can be obtained. Blasting patterns, types of explosives and blasting procedures can be assessed. Information on required processing and processing equipment (grizzlies, crushers, screens, etc.) can be obtained. When visiting quarry operations, check sheets should be prepared and filled out to assure that pertinent information is obtained. Items which should be included in such check sheets are shown in Table 3-1.

DEVELOPMENT OF REGIONAL GEOLOGY

DATA COLLECTION

INTERAGENCY COORDINATION AND COOPERATION

Sources of geologic, hydrologic and soils data; insight into geologic hazards and HTRW problems; seismicity; construction materials; prior regional experience.

SURVEY OF AVAILABLE INFORMATION

Information similar to that obtained in interagency coordination; published data on material properties; geologic conditions and history; hazards; ground water studies.

MAP STUDIES

Formation descriptions and contacts; soil types and locations; gross structure, fault locations; drainage, slopes, landslides; springs; quarries; etc.

REMOTE SENSING STUDIES

Landforms; drainage; linears; soil and rock type boundaries; outcrops; seeps; sinkholes; slopes; erosion features; vegetation; etc.

FIELD RECONNAISSANCES

Ground truth for remote sensing; outcrop descriptions; site terrain; soil depths and descriptions; springs; observable structure, bedding, joints; possible structure locations; mine and excavation surveys.

DATA ANALYSIS

DISTRIBUTION OF ROCK TYPES

Transition from time-stratigraphic units to grouping of rock materials by physical characteristics.

DISTRIBUTION OF SOIL TYPES

Equate geologic/soil nomenclature to engineering nomenclature.

GEOLOGIC STRUCTURE

Establish spatial location of rock materials; locate major structural features; determine probable distribution of more detailed structural and textural features.

GEOLOGIC HISTORY

Genesis of rock types; relationship to significant properties; rock and soil depositional processes; relationship to properties and preconsolidation history.

SEISMICITY

Historical seismicity; locations and characteristics of probable capable faults; possible earthquake magnitudes in region; possible intensities at candidate sites; preliminary selection of ground motions at candidate sites.

HYDROGEOLOGY

Regional ground water picture; general hydraulics of subsurface materials; probable ground water and seepage conditions at candidate sites; preliminary assessment of project impact on ground water.

CONSTRUCTION MATERIALS

Existing sources in region located; probable areas for rock and soil sources delineated

Regional geologic and soils conditions established; preliminary assessments of seismicity and construction materials; tentative models of geologic conditions at potential sites developed; preliminary inputs to EIS and HTRW reports developed.

Figure 3-1. Schematic diagram of the development of regional geology (adapted from EM 1110-1-1804)

Table 3-1
Items for Inclusion in Quarry Inspection Check Sheets

Project and quarry	Blast hole drilling sizes and patterns	Rock size and gradation requirements
Dates of operation		
Purpose of quarry	Explosives used and powder factors	Volumes of rock produced
Rock type with lithologic descriptions	Hauling and processing equipment	Records of disputes between contractor and client
Rock structure and fabric	Relation of natural block sizes to rock comminution	Rock service records
Descriptions and costs of investigations	Amounts of rock waste	Remarks
Lab test data		

Chapter 4 Field Investigations

4-1. General

As previously shown in Table 2-1 for the feasibility phase and the preconstruction engineering and design phase of project development, geotechnical field investigations may be divided into two stages: Site Selection and Initial Field Investigations, and Foundation and Design Investigations. The need for this division depends on the planned size and complexity of the project. As a simple rule of thumb, if there is an envisioned need for test quarry and test fill operations, the two stages of field investigations are probably justified. Figures 4-1 and 4-2 show the required investigation steps for the two investigations stages. Guidance specific to the layout and conduct of the field investigations required to locate and design test quarry operations is provided in the following paragraphs.

4-2. Geologic Mapping

Surface geologic maps of potential test quarry sites should be prepared during the areal and site geotechnical mapping phase of the site selection investigations. The regional geologic maps, developed during the reconnaissance phase, commonly will have scales of 1:62,500 or larger. Depending on the size of the project, the areal (e.g. reservoir) geologic maps prepared during the current investigations phase may have scales of between 1:12,000 and 1:62,500. Structure site geologic maps would have scales of from 1:1,200 to 1:4,800. Potential test quarry sites should be mapped at scales comparable to larger scale site maps. The scales should be such that soil and rock type contacts can be shown, the location and shape of individual outcrop areas can be plotted, observed bedding and joint symbols can be plotted without cluttering the map, planned surface geophysical and core boring exploration plans can be shown, and planned excavation layouts can be shown. The outcrop mapping method is best for this type of work. An excellent reference for this type of mapping is Compton (1962). The geologic map produced and accompanying test data should include a complete lithologic classification description of the rock types present. In addition, the degree of weathering existing in the rocks at the site should be detailed.

4-3. Geophysical Investigations

Detailed guidance and information concerning the use of exploration geophysical methods and equipment are contained in EM 1110-1-1802. Of specific interest in quarry site explorations are: overburden depths, location and orientation of rock contacts, groundwater depths, seismic velocities, and rippability. Of the available surface geophysical exploration methods, seismic refraction, reflection profiling, and electrical resistivity are relatively economical and will provide the required information. Of the available borehole methods, up and downhole seismic, and electrical logging will provide the appropriate data. The spacing of surface seismic and electrical resistivity lines should be a function of the variability of top of rock elevations and rock-type distribution as inferred from the detailed geologic mapping.

4-4. Subsurface Explorations

The subsurface explorations stage can be carried out concurrently with or toward the end of the surface geophysical stage. Lagging behind the start of surface geophysics allows the results of the geophysical profiling to assist in the layout of the boreholes. Conversely, borehole information will assist in the interpretation of the geophysical data.

a. Core borings. For the purposes of exploring the sites of proposed rock excavations and test quarries, with rare exception, rock core borings are the most suitable drilling method. For most investigations in hard rock, "N" size diamond core borings which acquire a nominal 5.1 cm (2-in.) diameter core are satisfactory. For soft and/or highly fractured rocks, "H" size (nominal 7.6 cm (3-in.) diameter cores) or 10.2 cm to 14.0 cm (4 in. to 5.5 in.) diamond core borings may be necessary. As with the spacing of surface geophysics lines, the number and spacing of exploratory borings is a function of the anticipated rock variability. The borings should be arranged to facilitate the preparation of geologic cross sections with the borings at the ends of the anticipated cross sections outside the planned excavation limits; interpolation is much less risky than extrapolation. Borings should be located at the intersection of geophysical profiles to assist in correlation. Depending on the surface mapping results, it may be necessary to drill a number of angle holes to eliminate bias in borehole fracture surveys. Barring other

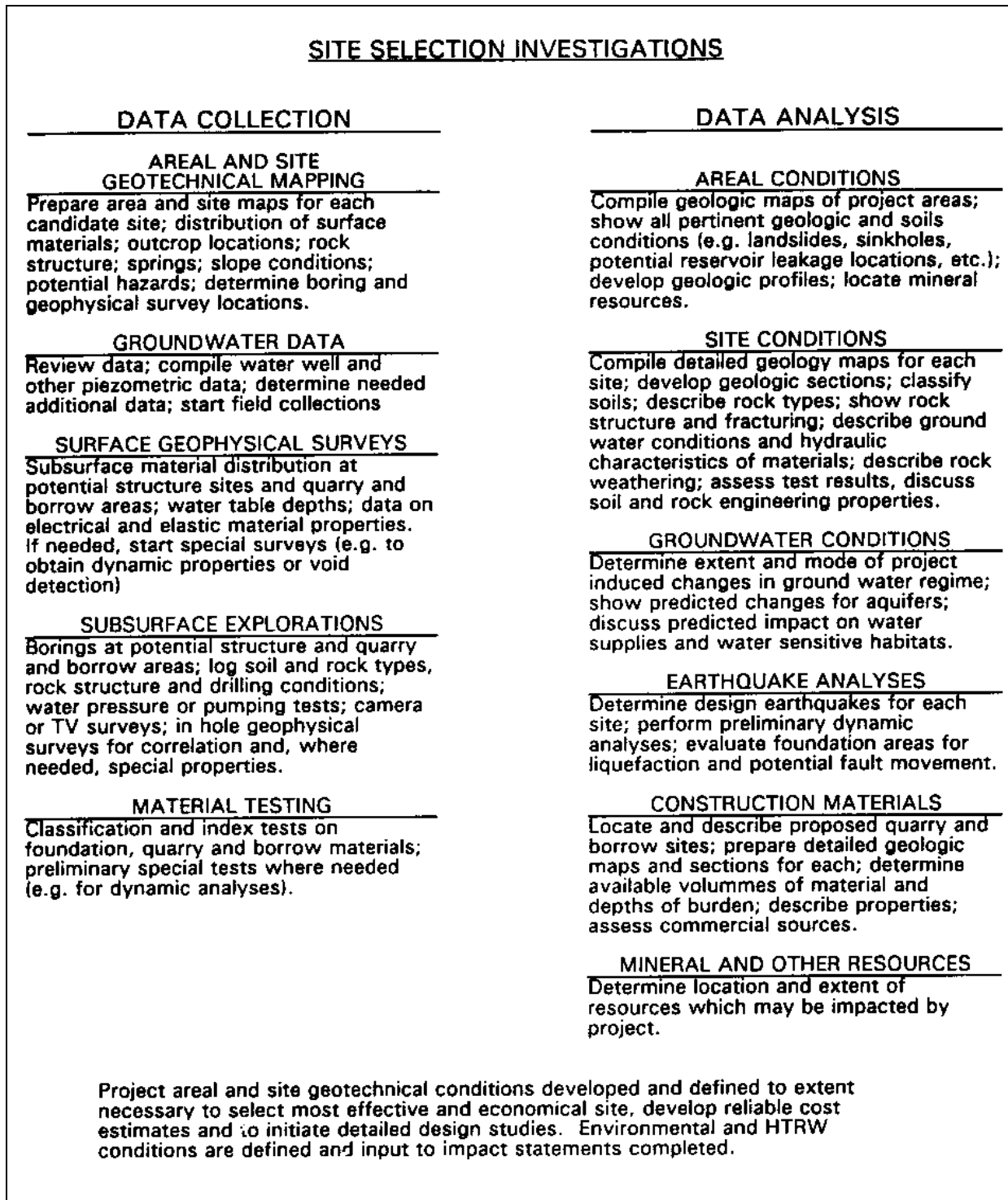

Figure 4-1. Schematic diagram of initial and site-selection investigations (adapted from EM 1110-1-1804)

considerations, or purposes for the borings, the depths of the core borings should be 1.25 to 1.33 times the depth

from the ground surface to the bottom of the planned excavation.

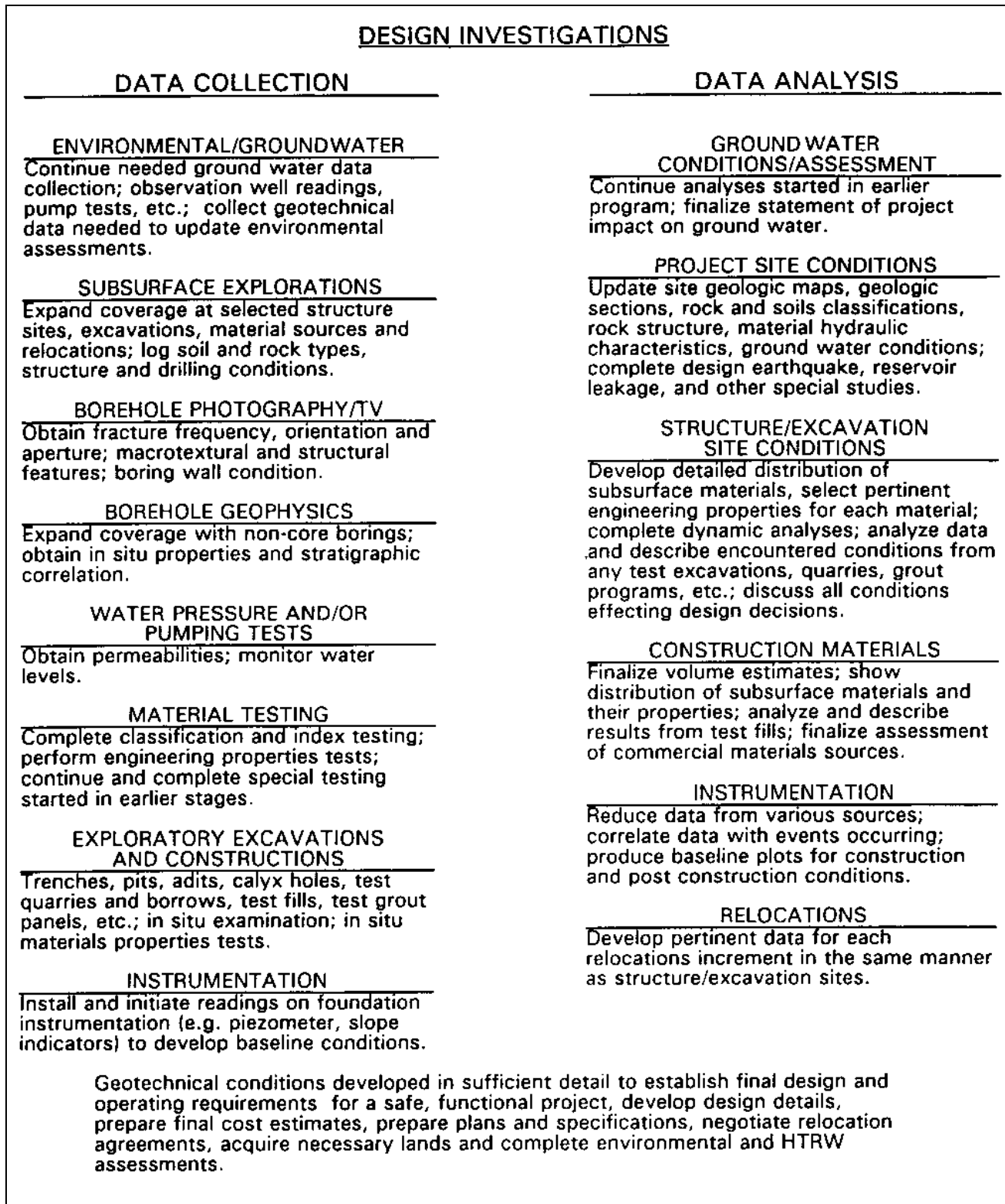

Figure 4-2. Schematic diagram for design investigations (adapted from EM 1110-1-1804)

b. Drilling, inspection, and sampling. General guidance for drilling, inspection, and core logging is contained in EM 1110-1-1804. The U.S. Bureau of Reclamation Engineering Geology Field Manual (1989) and Murphy (1985) contain comprehensive information on both core and soils logging and on rock mass descriptions. All of the rock descriptors recommended in the cited references are important to test quarry applications. Of particular importance are weathering, presence of clay or gouge seams, and the in situ gradation. Given a rock material of certain hardness and density, these types of descriptors will form the basis for estimates of waste and the need for and design of rock processing equipment. The degree of weathering should be described according to some standard such as that contained in EM 1110-1-1804. In situ fracture frequency and orientation can provide the information required to calculate in situ rock block-size distribution. In addition, correlations have been developed between rock-quality designation (RQD) and mean fracture frequency. The general use of RQD is treated in ETL 1110-1-145. When logging rock core, in addition to logging core loss and RQD, the geologist/inspector should note the depth and angle (with respect to borehole axis) of every identifiable fracture and note its genesis (joint, bedding plane, drill break, etc.). As a practical matter, when the fracture spacing is less than 3.0 cm (0.1 ft), that interval of core may be logged as "broken." This data will allow the prediction of in situ rock block-size distributions. In addition, it will be of value for the geologist/inspector to note those parameters which are used in currently popular rock mass classification systems such as "RMR" or "Q" systems (ASTM 1988). The use of rock mass classification systems is discussed further in Chapters 6 and 7. Information and guidance on sampling and sample preservation of soils and rock core are contained in EM 1110-1-1906, and ASTM Designations: D 4220 (ASTM 1994a) and D 5079 (ASTM 1994b). Sample

preservation for moisture content is generally not necessary in hard, crystalline rocks. Such rocks generally exhibit intact rock material porosities less than one percent and moisture content is inconsequential to densities and other parameters. In softer sedimentary or chemical precipitate rocks, the porosities are sufficiently great that moisture content does affect bulk densities and other parameters. In these rocks, the geologist/inspector should select and preserve representative samples for moisture content determinations.

c. Borehole examination and in-hole testing. Borehole examination and in-hole testing includes borehole photography, TV and sonic imaging, borehole geophysics, hydraulic or water pressure testing, water table measurements, and in-hole deformation or jacking tests. Guidance and information on these methods are contained in EM 1110-1-1802, EM 1110-1-1804, the Corps of Engineers Rock Testing Handbook (USAEWES 1993), and the U.S. Bureau of Reclamation Engineering Geology Field Manual (1989). The borehole geophysical methods most pertinent to test quarry explorations have been described in paragraph 4-3. Tests to determine in situ stresses would be warranted only if there were indications of abnormally high horizontal stresses which might affect excavation slope stability and markedly affect rock breakage. For test quarry explorations, water pressure testing normally would not be necessary. Water table measurements are necessary for excavation slope and dewatering design purposes. For test quarry explorations, borehole photography, TV, and sonic imaging are the most important measurements. Because they provide detailed information on rock structure, these measurements will provide input to design analyses of probable rock waste, in situ rock block-size distribution, trial blast patterns and loading, and rock excavation slope stability calculations and slope design.

Chapter 5 Laboratory Testing

5-1. General

As shown in Figures 4-1 and 4-2, material testing is part of both the Site Selection and the Design Investigations. In terms of timing or scheduling, laboratory material testing would be performed as close to concurrent with the subsurface exploration stages as possible. EM 1110-1-1804 provides guidance and information on types of soil and rock tests for various design applications. EM 1110-2-1906, the Corps of Engineers Rock Testing Handbook (USAEWES 1993), and ASTM (1994a through 1994d) all provide detailed information on the procedures for conducting tests on soil and rock materials. Rock and soils tests are informally divided into two categories: index tests to identify and classify the materials, and engineering properties tests to supply parameters for design analyses. The following paragraphs discuss the applicability of selected tests for test quarry design.

5-2. Petrographic Examination

A detailed discussion of recommended practice for petrographic examination of rock cores is contained in the Corps of Engineers Rock Testing Handbook (USAEWES 1993). Petrographic examinations are conducted to describe, classify, and determine the relative amounts of the sample constituents, identify the sample lithology, to determine the sample fabric, and to detect evidence of rock alteration. The identification of rock constituents and determination of fabric and micro-structural features assist in the recognition of properties that may influence the engineering behavior of the rock. Complete petrographic examination may require the use of such procedures as light microscopy, x-ray diffraction, differential thermal analysis, and infrared spectroscopy. The selection of specific procedures should be made by an experienced petrographer in consultation with geologists and engineers responsible for the design and execution of the test quarry program.

5-3. Weight/Volume Properties

The weight/volume and pore properties of a rock material include specific gravity of solids, porosity and absorption, apparent and bulk specific gravity, moisture content, and degree of saturation. These properties are directly important to predictions of "swell" or "bulking" and serve as index tests relating rock strength and deformability. As a general rule, for test quarry design, bulk specific gravity

and absorption are the minimum weight/volume tests that need to be performed. If a quarry is intended to produce dimension or derrick stone, absorption and adsorption may provide an indication of the rock's long-term resistance to freeze-thaw and slaking. The relationships between bulk specific gravity (G_m), absorption (A_B), and porosity of the rock particles (n_r) are given below. The porosity here refers to the permeable voids associated with individual rock particles and not to the porosity of a compacted mass of such rocks.

$$G_m = \frac{A}{B - C} \quad (5-1)$$

$$A_B = \frac{B - A}{A} \quad (5-2)$$

$$n_r = A_B \times G_m \quad (5-3)$$

where

A = weight of oven-dry specimen

B = weight of saturated surface-dry specimen

C = weight of saturated surface-dry specimen in water

5-4. Strength Tests

Unconfined compressive strength is a well known index test relating intact rock strength and deformability. Further, it can be used with rock mass quality descriptors to infer rock mass strength parameters (Hoek and Bray 1981). Unless there are specific requirements relating to rock slope design problems, there is no need to perform tests such as the triaxial shear or direct shear tests. An inexpensive and rapid test which correlates to unconfined compressive strength is the point load test (Bieniawski 1975). This test is growing in popularity and can be performed either in the laboratory or the field.

5-5. Rock Durability Tests

Laboratory durability tests are divided into those that simulate accelerated weathering and those that measure physical properties. Accelerated weathering tests usually include wet and dry (Designation D 5313; ASTM 1994a), freeze and thaw (Designation D 5312; ASTM 1994a), sodium sulphate soundness and magnesium sulphate soundness (Designations D 5240 and C 88; ASTM 1994a and 1994b, respectively). Physical property tests include

EM 1110-2-2301
30 Sep 94

absorption (Designation C 127; ASTM 1994b), Los Angeles Abrasion (Designation C 535; ASTM 1994b), and slake durability (Designation D 4644; ASTM 1994c).

Chapter 6 Location and Design of Test Quarries

6-1. General

The final location, physical size, and design of a test quarry is made using the information obtained during the reconnaissance, site selection, and initial and design investigations. The development of the test quarry program and the test quarry design is an iterative process. Preliminary requirements for and locations of test quarries are developed during the reconnaissance phase of project development and refined sufficiently during the feasibility phase to provide accurate data for baseline cost estimates and for proceeding to detailed design during the preconstruction engineering design phase. The process of locating and designing the project test quarry, or test quarries, follows a logical sequence as described in the following paragraphs.

6-2. Evaluation of Project Rock Production Requirements

Concurrent with the investigations required to locate and design a test quarry are those required to determine embankment design, including zoning and slope protection requirements. The need for rock-fill zones in an embankment arises from the overall analyses of the amounts of different types of fill materials available and the results of cost studies of various embankment cross sections and alignments. The decision to design and construct a rock-fill embankment is made based on design safety considerations and on analyzing the comparative costs among rock, earth-rock, and earth embankments and concrete structures. Guidelines on the procedures for selecting the safest and most economical design are contained in EM 1110-2-2300. As the embankment design develops, volumes for different qualities and gradations of rockfill are determined. These are compared with the probable amounts of rock of those qualities and gradations that design investigations indicate are available in required excavations or in separate excavations specifically planned to supply rock material. This process is iterated until the most economical balance between excavation and fill requirements is obtained which will produce a safe embankment. The supply of rock reserves available for construction of the dam must be accurately estimated, taking into account bulking and/or shrinkage factors. These quantity estimates can be greatly improved if bulking and shrinkage factors are determined during test quarry and test fill development.

6-3. Evaluation of Potential Test Quarry Sites

At this stage in the design process, required excavation and/or stand-alone quarry sites have been explored as potential sources of construction materials. It remains to evaluate these sites and decide upon one or more test quarry locations which will provide data that are most representative of the conditions to be encountered in the project excavation(s). The quarry or quarries should be sited so that all large-volume rock types to be used in construction and all associated rock conditions will be assessed and tested. If the amount of a particular rock type will be relatively small and failure to assess it will result in errors of minor technical and economic consequences during construction, the time and cost of developing a test quarry only to assess it may not be justified.

a. Rock type distribution considerations. The test quarry, or quarries, should sample the same rock types, in roughly the same proportionate quantities, that will be provided from the actual project excavation(s). A project may be located in one rock or several depending on the areal geologic sequence (sedimentary, igneous, metamorphic). The degree of heterogeneity will control the number and location of test quarries. In a relatively homogeneous igneous or metamorphic crystalline rock, one test quarry of sufficient size to sample the unweathered rock may suffice. In a bedded sedimentary sequence, a large spillway excavation may be planned to cut across several rock types. Ideally, the test quarry should be of sufficient size that it will sample this heterogeneity and supply adequate materials for test fills. However, monies available at this stage may not allow a test quarry of that size. A number of smaller test quarries may provide a representative blend of materials for test fills and provide representative information on rock gradations, waste and slope design. However, great care must be used in modeling of the rock conditions to be produced from one large excavation with a number of smaller excavations. As will be pointed out in paragraph 7-2b, there are potential problems involved in not siting the test quarry within the area of the intended project borrow excavation.

b. Geologic structure and fabric considerations. Test quarries should not be located so that they include gross or meso-scale geologic structural features such as faults and solution cavities. Macro-scale geologic structure, such as joints and bedding planes, affects both the gradation of the blasted rock mass and the stability of the quarry slopes. The regional residual stress field will have an effect on quarry slope stability and on rock

fragmentation. The effect of the geologic structure on the design of the quarry slopes will be discussed below in paragraph 6-3d and its effect on the blasted rock mass gradation will be discussed in paragraph 6-3c. Geologic fabric, or arrangement of the rock's mineral constituents, affects both the ease with which comminution occurs under the dynamic loads of explosives and the shape of the blasted rock fragments. The test quarry, or quarries, should be sized and located so that all the variations of geologic structure which will be encountered in the project quarry excavations will be sampled. Generally, an adequate sampling of rock fabric is obtained if the test quarry, or quarries, adequately sample all the rock types to be encountered in the project construction situation.

c. Rock quality and gradation considerations. As with rock type, geologic structural and fabric considerations, the number and size of test quarries should be selected so that the variations in rock quality over the planned construction quarry excavations are sampled. If, as recommended in paragraph 4-4b, sufficient data were collected during subsurface investigations to employ the use of a rock-mass classification system, the rock mass in the required excavations can be divided into zones of different rock mass qualities and that zoning can assist in the location of the test quarries. The in situ rock block-size distribution will have a great deal of influence on the gradation of the blasted rock. The degree of variation of in situ block-size distribution can be established from the logs of exploration core borings. There are two ways to assess this degree of variation. Mean block-size distribution for pre-selected lengths of each bore hole can be estimated from *RQD* using the following relationship (Brady and Brown 1985).

$$RQD = 100 e^{-0.1\lambda} (0.1\lambda + 1) \quad (6-4)$$

where e is the exponential and λ is the mean number of discontinuities per meter. Figure 6-1 shows the relationship between *RQD* and mean discontinuity frequency. A more site-specific and accurate method of estimating the in situ block-size distribution is to make cumulative fracture frequency curves from the fracture counts on the boring logs and/or from borehole photography logs. This will allow the division of the rock mass by the mean fracture spacing and variance in a manner similar to zoning the rock mass according to rock mass quality.

d. Rock slope design considerations. Because the test quarries will provide the opportunity to test the project excavation slope designs, the test quarry excavation(s) should be configured to duplicate project slope

inclinations and orientations. As part of the test quarry location and sizing analyses, slope stability evaluations should be employed for trial quarry configurations. Preliminary evaluations of slope stability can be performed with graphical analyses using stereographic or equal-area projections. An example of such an evaluation is shown in Figure 6-2. If preliminary evaluations indicate potential instabilities, more detailed planar and wedge stability analyses should be performed. An excellent series of discussions on rock slope stability analyses is presented by Hoek and Bray (1981). There should be sufficient slope area to test all potential presplit configurations.

6-4. Test Quarry Layouts

Test quarries should be located, if feasible, within the perimeter of the area to be used as the primary source of rock for project construction. Reasons for this will be discussed in paragraph 7-2b. As stated in paragraph 6-3, the quarry, or quarries, should be located so that all major rock types and rock conditions can be tested and evaluated. It is presumed that, before final selection of the test quarry site(s), sufficient core borings will have been drilled in each potential quarry location to determine if the desired rock type and rock conditions will be encountered in the selected test quarry(ies). The layout of each quarry must take into consideration the slope of the terrain, the depth of overburden and saprolite, the configuration of the objective strata, and accessibility to the test fill site. Cost of the test quarry is always a consideration; the location and layout must achieve reasonable economy. Figures 6-3 through 6-6 are examples of single-test and multiple-test quarry layouts, respectively.

a. Stripping requirements. It is necessary to strip all of the overburden and saprolite and haul it to a disposal site prior to initiation of rock excavation in the test quarry. This is important because the rock fill produced in the test quarry should not be contaminated by the overlying materials. It is advisable to create a berm or bench on the order of 3 to 7 m (10 to 20 ft) wide between the base of the slope through overburden and the beginning of the first rock excavation slope. This should be done to control surface drainage and raveling of overburden into the quarry during the continuing excavation.

b. Size and alignment. The size of the test quarry is dictated by a number of different factors. Depth to the target rock formation, quantity of material required for test fills, geologic structure and side slopes, variations in rock types and rock quality, and the number of test blasts needed are all factors which must be considered in

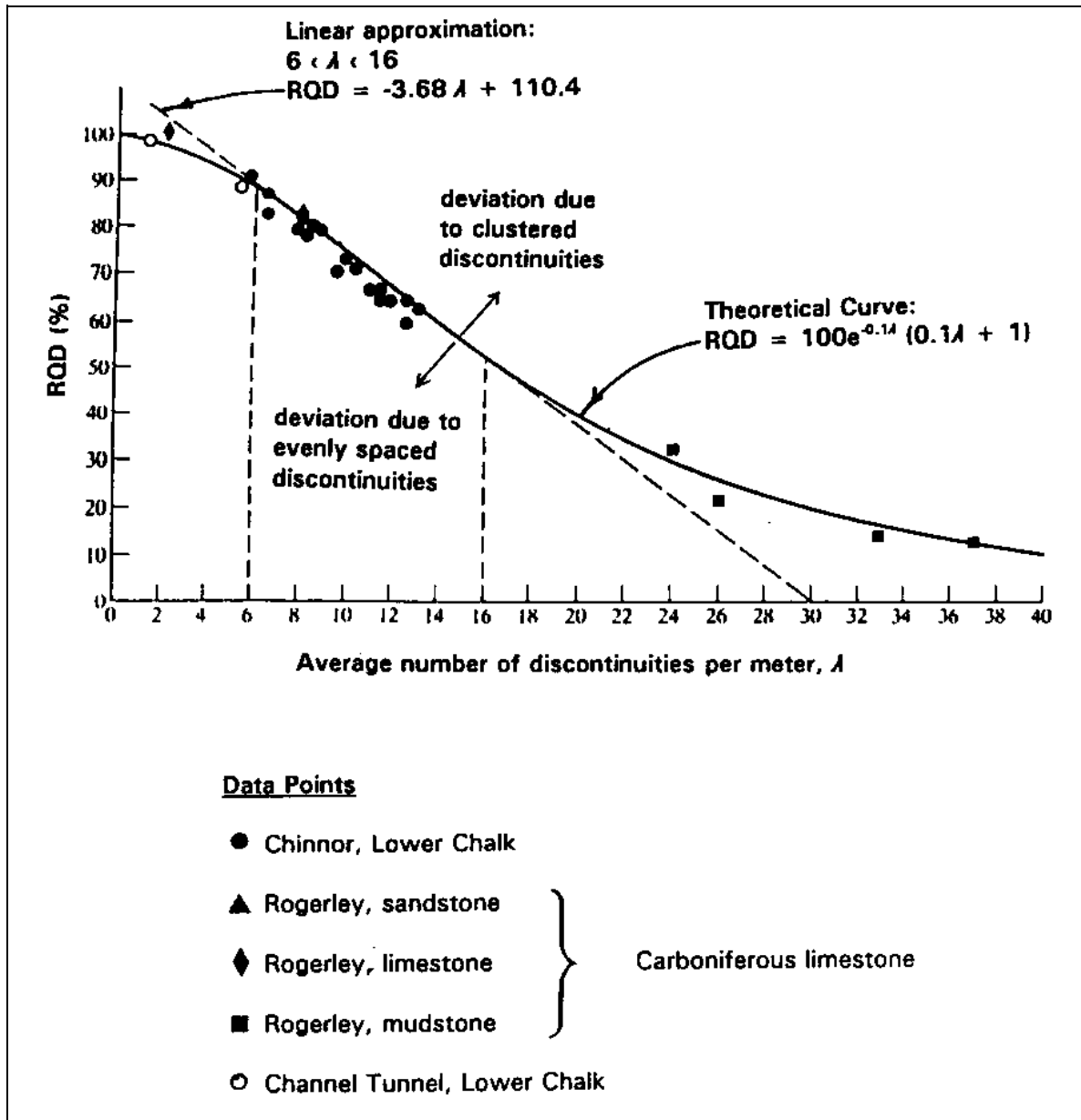

Figure 6-1. Relationship between *RQD* and mean discontinuity frequency (after Brady and Brown 1985)

designing the dimensions of the test quarry(ies). It is important to plan the size of the excavation larger than the minimum required in case it becomes necessary to excavate the quarry deeper than the design depth. Extending an exact-sized quarry to greater depth would require re-excavating the slopes in order to maintain their stability. This may become prohibitively expensive. The alignment of the excavation is affected by some of the factors that affect its size but terrain configuration

frequently controls the alignment. An example of terrain-controlled alignment is shown in Figures 6-3 through 6-5.

c. Slope and bench designs. Slope design should be based upon rock slope stability analyses employing rock fracture orientations developed from the geologic investigations and rock shear strengths developed from the results of laboratory testing. One purpose of the test quarry is to field test the slope design. For this reason,

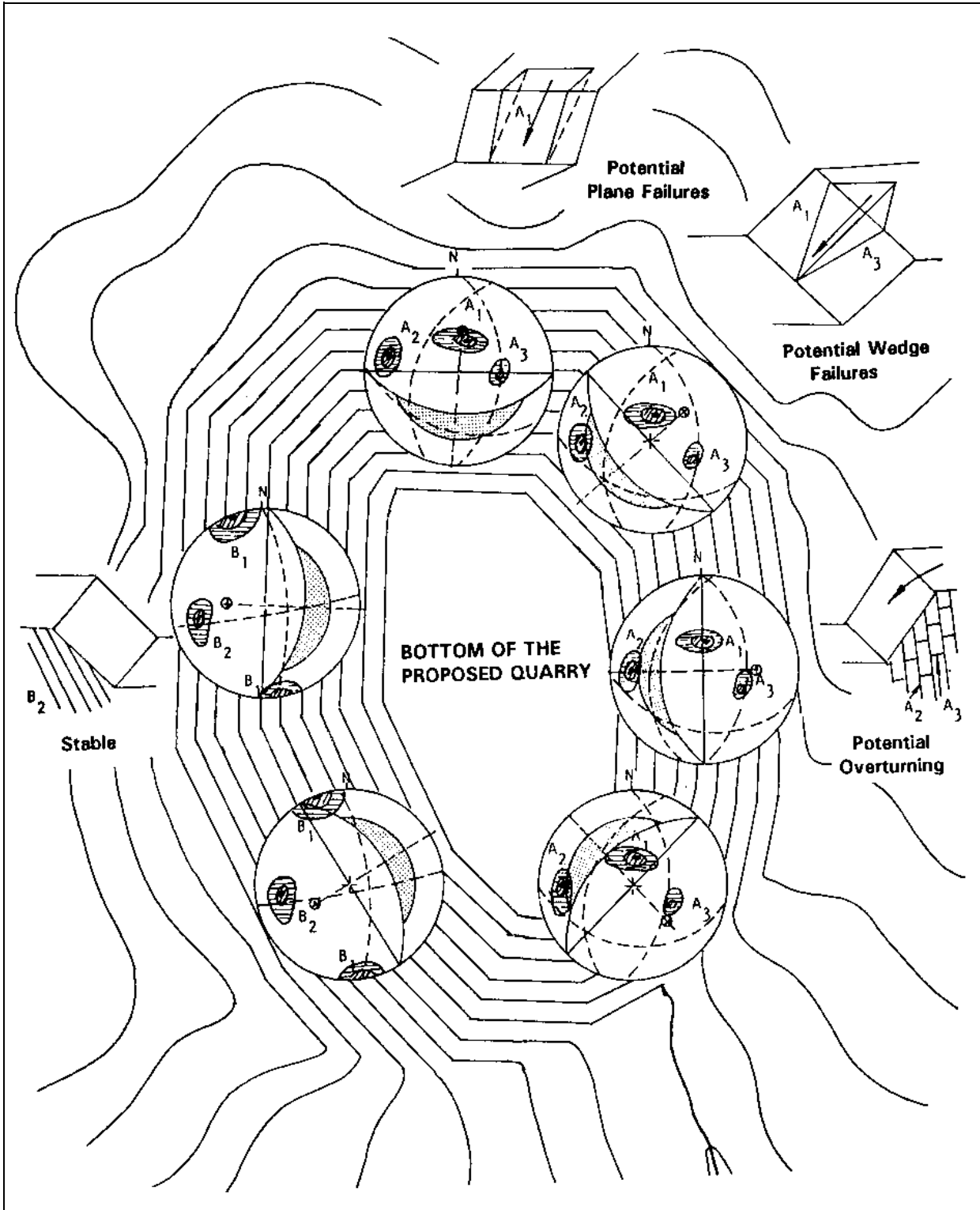

Figure 6-2. Example of a graphical slope stability evaluation of a proposed excavation (after Hoek and Bray 1981)

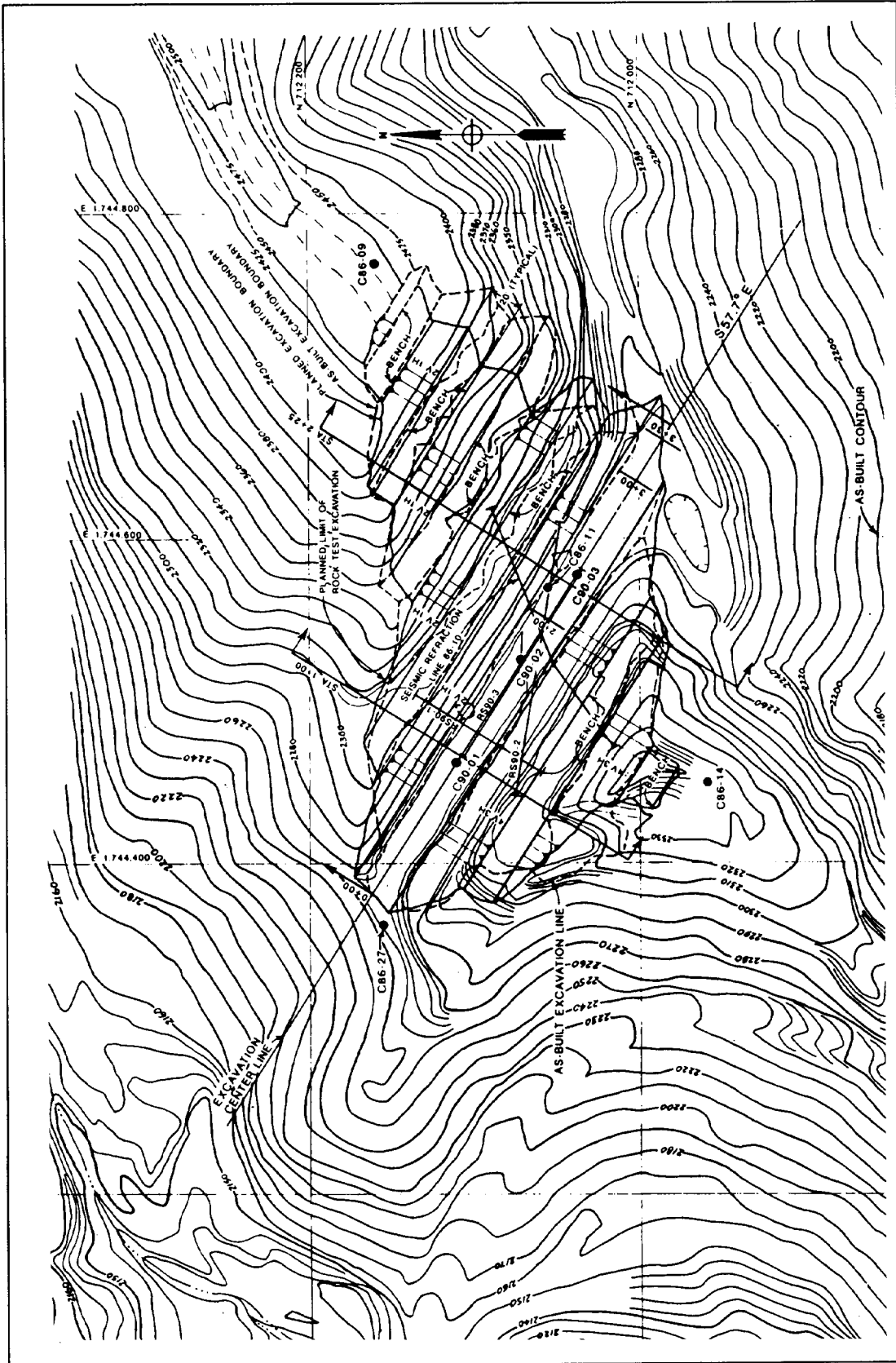

Figure 6-3. Example of a single test quarry layout showing bench and slope configurations, Seven Oaks Dam (after U.S. Army Engineer District, Los Angeles 1992)

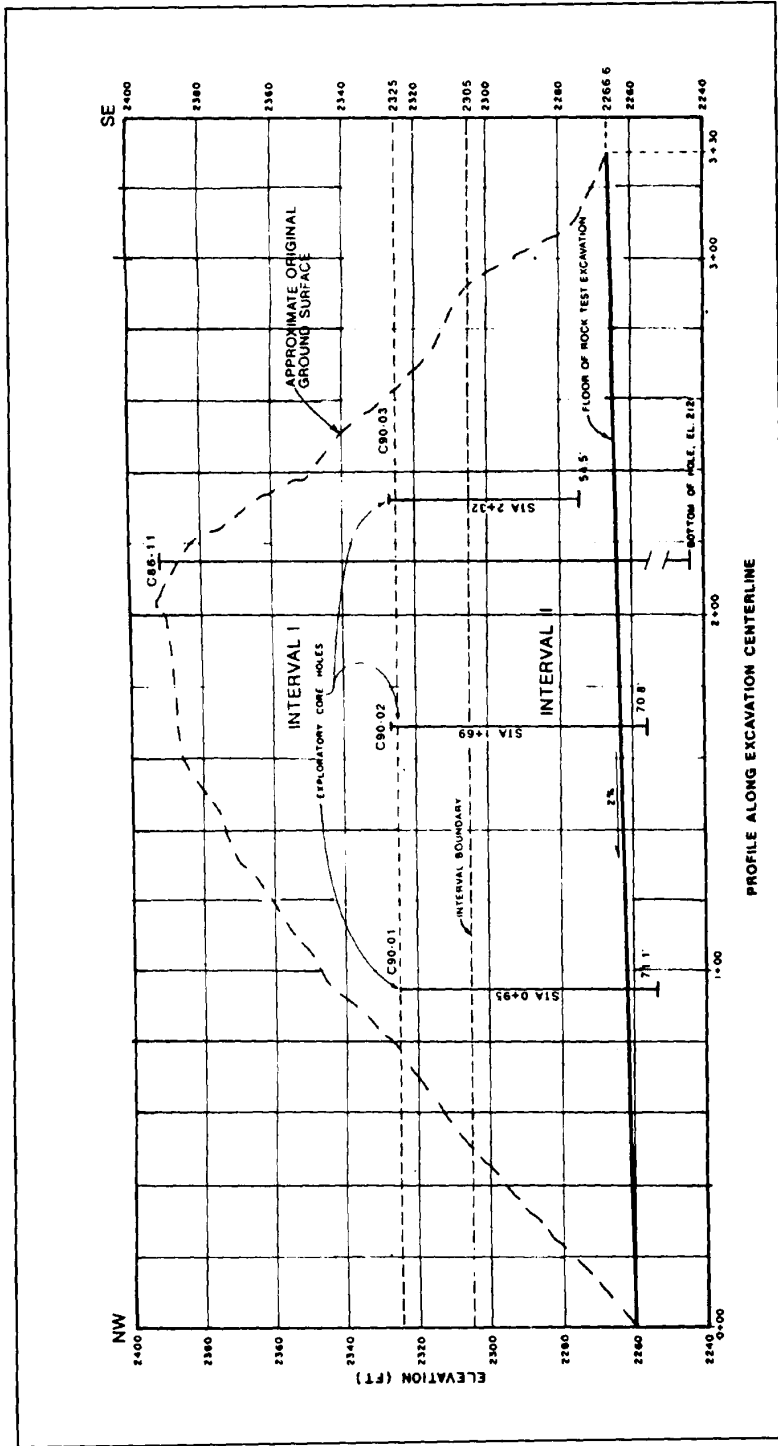

Figure 6-4. Profile along the excavation centerline of Figure 6-3

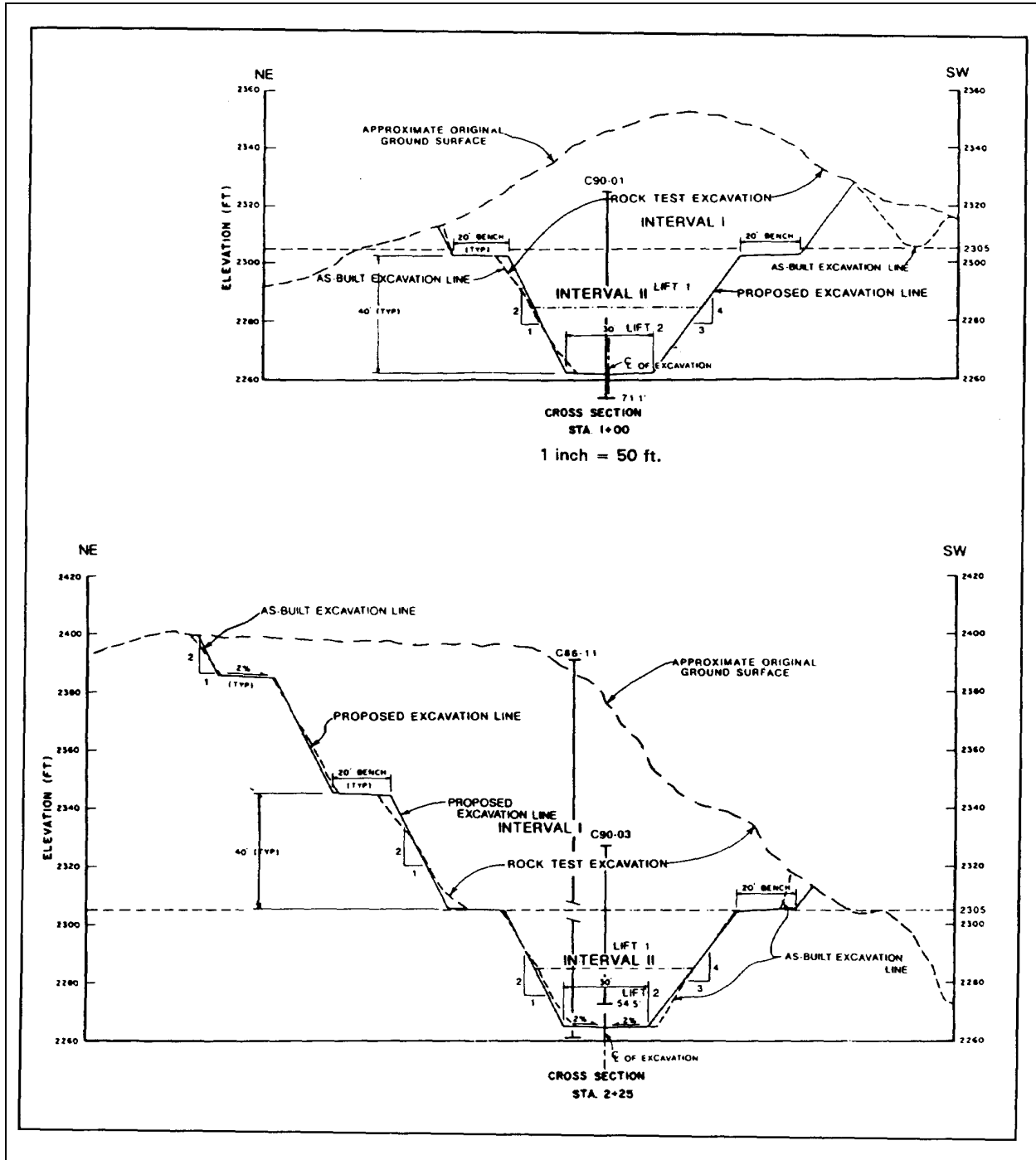

Figure 6-5. Additional sectional views of single quarry shown in Figure 6-3

several variations of the design should be tested in the quarry to prove and optimize the design. Bench design is based upon the overall slope stability analysis and upon the practicalities of excavation. The benches have the effect of flattening the overall slope and improving stability. They also provide added safety by catching some of

the falling rock before it reaches the quarry floor. The benches can be sloped to control surface drainage and to provide haul road access to the quarry floor. Examples of slope and bench configurations are shown in Figures 6-3 through 6-5. Quarry bench height designs should be

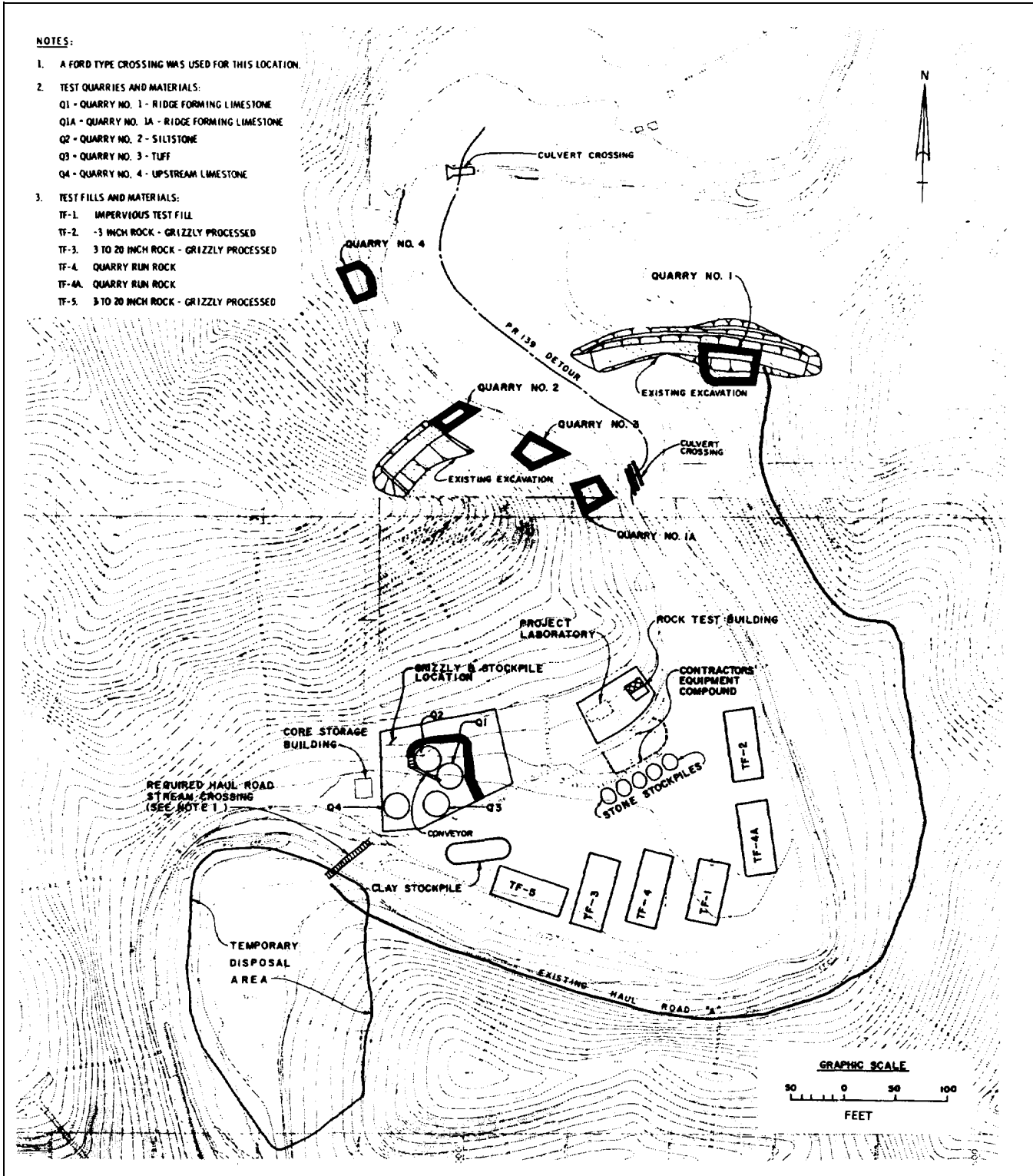

Figure 6-6. Example of a multiple test quarry layout where samples from several different rock strata are required for testing (after U.S. Army Engineer District, Jacksonville 1983)

based on anticipated excavation and hauling equipment and safety. Control of produced rock gradation is more a function of explosive type, quantity per hole, blast-hole spacing, decking of the charge, and burden than bench height. Where practicable, setting quarry benches coincident with slope berms will be efficient from a constructibility standpoint.

d. Presplitting patterns. The presplitting patterns developed during the design phase should be tested in the test quarry excavation. Variables in the design include hole spacing, hole size, stemming subdrilling, inclination, loading configuration, and charge weights. Hole spacing normally ranges from 46 to 91 cm (18 to 36 in.). The quality of the presplit slope normally decreases as the hole spacing increases, with 91 cm (36 in.) being about the maximum that will produce a satisfactory slope. It is important to maximize suitable spacing because this will reduce the number of presplit holes required and thereby reduce drilling costs. Good drilling alignment is very important to a satisfactory presplit slope cut. Alignment requires great care, particularly when drilling from rough or irregular surfaces. The techniques employed by the driller also affect the resulting alignment. It is important to specify great care in maintenance of alignment in the test quarry contract. It is also important to optimize the buffer zone between the presplit slope and the production blast lifts. Too large a buffer zone will keep the production blasts from pulling completely to the presplit slope and may result in incompletely broken rock. Too small a buffer zone will result in damage to the slope by the production blast. Variations of the combination of the above variables should be tested to determine which will work best under individual slope conditions. The basic designs should be furnished to the field with instructions that it will be modified as testing progresses and more is learned about the behavior of the rock mass. EM 1110-2-3800 provides detailed guidance on presplit design.

e. Production blasting patterns. There are numerous variables involved with blasting patterns which affect the particle size and gradation of the blasted rock pile. These variables and combinations thereof need to be investigated during the test quarry development to determine which combinations provide the most desirable rock fragmentation and gradation. Those variables that should be tested include: blast-hole diameter, hole spacing, powder factor, subdrilling depth, stemming type and length, type of explosive, loading configurations, decking, bench heights, firing delay patterns, and location of the free face (burden). It must be recognized that the characteristics of the rock mass impose limitations on the size of the produced particles. For instance, if rock joints occur on a repeating

frequency of 30 cm (1 ft), it will not be possible to obtain significant quantities of rock with intermediate dimensions exceeding 30 cm (1 ft), no matter how the blasting pattern is designed. In other words, do not attempt a blast design to create fragmentation which is impractical to achieve. It is possible to achieve a gradation finer than the in situ gradation but not coarser. With this limitation understood, variations in the combinations of variables should be tested to develop those combinations which provide the most satisfactory rock mass fragmentation and gradation. The test quarry design should provide those patterns to be tested. The contract should provide for variations as more is learned from the initial tests. Figures 6-7 and 6-8 show examples of variations in test blasting patterns used to develop optimum patterns. EM 1110-2-3800 provides details on blast pattern design.

6-5. Gradation Measurements

There are no established standards or procedures specifically directed at making gradation determinations for blasted rock to be used in compacted rock fills. The new ASTM Designation D 5519-93 (ASTM 1994d) has become available (but not in time to be included in ASTM 1994a) for making gradation determinations for riprap and may be considered applicable. A complete discussion of gradation testing including ASTM 1994d is provided in Part II: Test Fills. The procedures used at the Corps of Engineers Carter's, Cerrillos, and Seven Oaks dam projects and described in the following paragraphs represent the typical sorts of past practices relative to obtaining gradations for rock materials upon which the ASTM standard for riprap was based.

a. Carter's Dam. The gradation measurement procedure was to first carefully select a large representative sample from the blasted rock pile. The rock was then processed by hand over a series of inclined screens that separated the rock fragments into fractions of over 2.5 cm (1 in.), 7.6 cm (3 in.), 15.2 cm (6 in.), and 20.3 cm (8 in.). The minus 2.5-cm (1-in.) fraction was then processed with a Gilson® shaker using a normal nest of U.S. Standard Sieves (EM 1110-2-1906). The fragments from that fraction of the sample which were larger than 20.3 cm (8 in.) were individually passed through 30.5-cm (12-in.), 40.6-cm (16-in.), and 61-cm (24-in.) squares in order to determine the percent passing each of those sizes. It is necessary to obtain progressively larger representative samples for testing as the maximum particle size increases in order for the test results to be a satisfactory representation (estimation) of the blasted rock gradation. Figure 6-9 shows the configuration of the rock

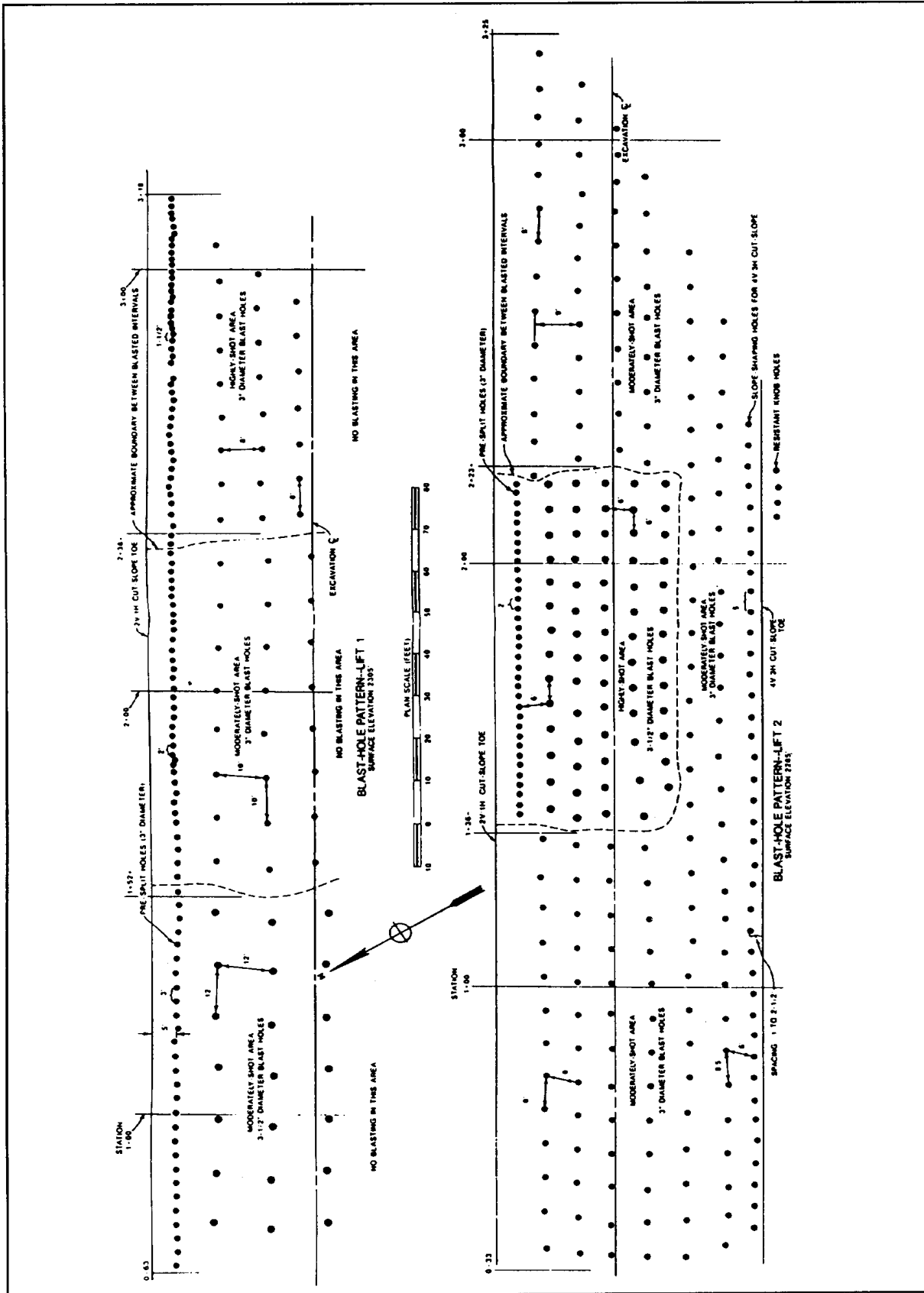

Figure 6-7. Example of variations in test blast patterns designed to develop the optimum production blast patterns (after U.S. Army Engineer District, Los Angeles 1992)

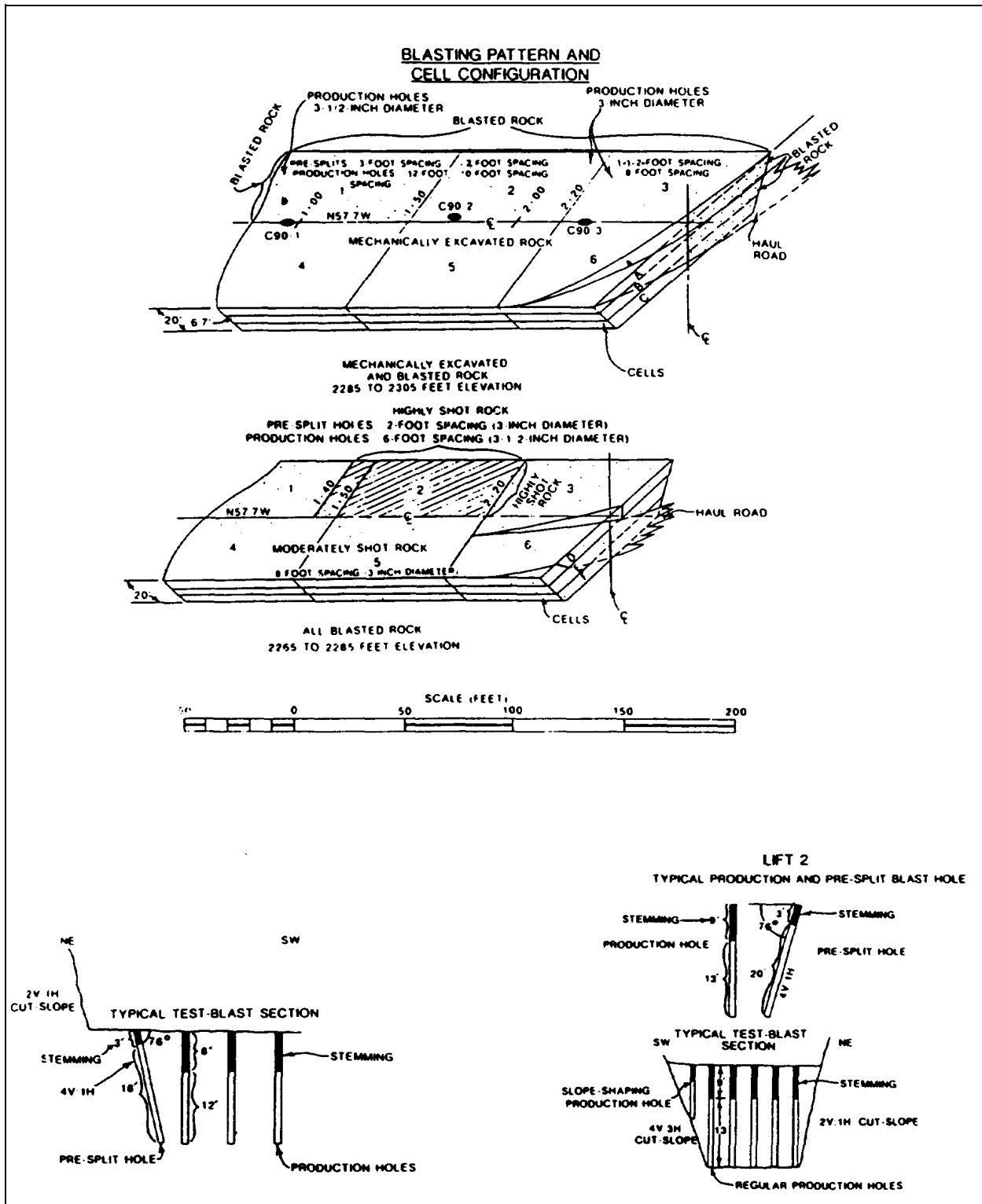

Figure 6-8. Additional information relative to Figure 6-7

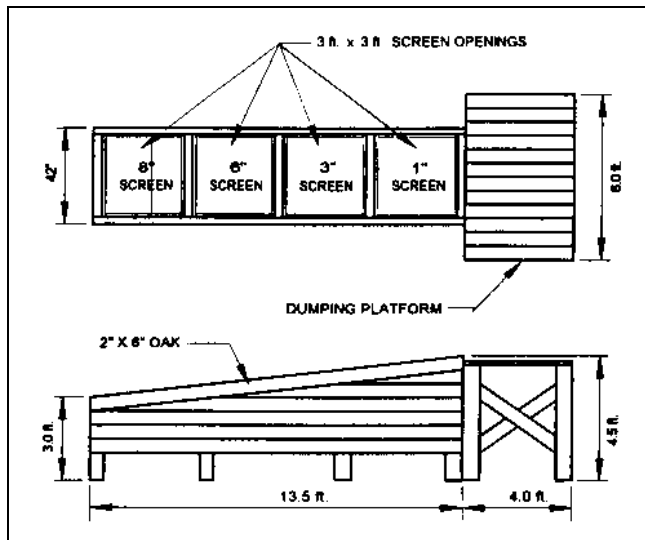

Figure 6-9. Example configuration of a rock gradation screening platform

gradation measurement platform used at Carter's Dam. The above information was obtained verbally from Mr. C. Colwell of the South Atlantic Division Laboratory (1993).

b. *Cerrillos Dam.* The gradation measurement procedure at Cerrillos Dam began with selection of a large sample weighing about 13.6 metric tons (30,000 lb). This sample was then split by the quartering method to obtain a sample weighing about 2.7 megagrams or metric tons (6,000 lb). The 2.7-metric ton (6,000-lb) sample was processed by hand over 15.2-cm (6-in.), 20.3-cm (8-in.), 22.9-cm (9-in.), 30.5-cm (12-in.), and 61-cm (24-in.) screens. The fraction passing the 15.2-cm (6-in.) screen was processed through a nest of screens using the Gilson® shaker. The gradation was based on the percent passing each screen size. This information was obtained verbally from Mr. P. Davila, U.S. Army Engineer Jacksonville District, Ponce (Puerto Rico) Resident Office (1993).

c. *Seven Oaks Dam.* Samples weighing approximately 4.5 metric tons (10,000 lb) were obtained and dumped on large sheets of plastic. These materials were sorted manually in the field using 7.6-cm (3-in.) opening Tyler screen and 15.2-cm (6-in.), 22.9-cm (9-in.), 30.5-cm (12-in.), and 45.7-cm (18-in.) sizing rings. The materials passing through the screen and sizing rings were placed in 2.1-cu m (55-gal) drums and weighed in the field on a platform scale. Individual rock fragments larger than 45.7 cm (18 in.) were measured in three diametrical directions and the weights estimated based on previously

developed correlation charts. One drum of the minus 7.6-cm (3-in.) material from each sample was taken to the project laboratory for sieving and classification testing. This description was taken nearly verbatim from the U.S. Army Engineer District Los Angeles District Feature Design Memorandum (1992).

6-6. Deterioration and Incipient Fracture Examination

Some rock formations tend to deteriorate after excavation due to physical and/or chemical processes. This can have a very degrading effect on the rock products manufactured for various zones in a rock-fill dam and should be carefully evaluated during test-quarry and test-fill construction. Some conditions which lead to this type of deterioration are incipient fractures, bedding planes, abnormally high residual stresses, and chemically and/or physically unstable strata such as shale and volcanic ash or tuff. Some of this deterioration may occur in stock piles while some may occur due to the mechanical actions of loading, hauling, placement, and compaction into the fill. It is important to identify and assess degradation during the test-quarry and test-fill operation so that it can be dealt with during final design and construction. There are several approaches to determining whether or not this is a problem. Perhaps the simplest is to expose samples of rock core and blasted rock to the environment for a defined period of time and measure either changes in specimen size or weight loss. No changes would be an indication that degradation by chemical effects or weathering is not likely to occur in the rock fill. If changes do occur, then more sophisticated tests are needed to evaluate the magnitude of the problem. Petrographic analyses have provided an indication of breakdown due to incipient fracturing. Visual observations of individual blasted rock fragments are useful in determining the presence of incipient fractures or weak bedding planes. If there is an indication of either chemical or physical breakdown, it is desirable to obtain gradations of the blasted rock mass in the test quarry, then subsequently in the stock pile and ultimately in the test fills. These successive gradations will provide information on the degree of degradation which occurs. In some cases, it may be necessary to test repetitively in a stock pile to duplicate the times that a contractor is likely to stockpile materials. It is important to note that the mechanical action of repeatedly testing the same sample over a period of time may itself be a factor in any observed breakdown. This is discussed further in paragraph 7-6b. The blasting process often enlarges and expands incipient fractures and planes of weakness in intact rock blocks. This process will lead to degradation of the stone during project operation. The identification

of blast damage is very important. Both District and Division Laboratory geologic personnel should be involved in the evaluation of blast damage.

6-7. Rock Processing

Rock processing is frequently called for in the design of an earth-rockfill dam. This is particularly true for the manufacture of filter materials and materials to be placed in zones adjacent to filters. Where processing is anticipated, it is important to process the rock being produced in the test quarry for the test fills. The decision to process for the project situation should be carefully

conceived and evaluated because rock processing, both in the test program and in the project construction, is very expensive. In other words, the fewer the zones of the dam that require processing, the less expensive the dam construction will be. The test fills should be constructed from rock materials that have the same characteristics as the project material is expected to have. In order to obtain this, some processing is likely to be required between the test quarry and the test fills. This may involve processing over a grizzly as diagrammed in Figure 6-10 or may require a portable crushing and screening plant to be brought to the site. Paragraph 7-7 provides further discussion of processing.

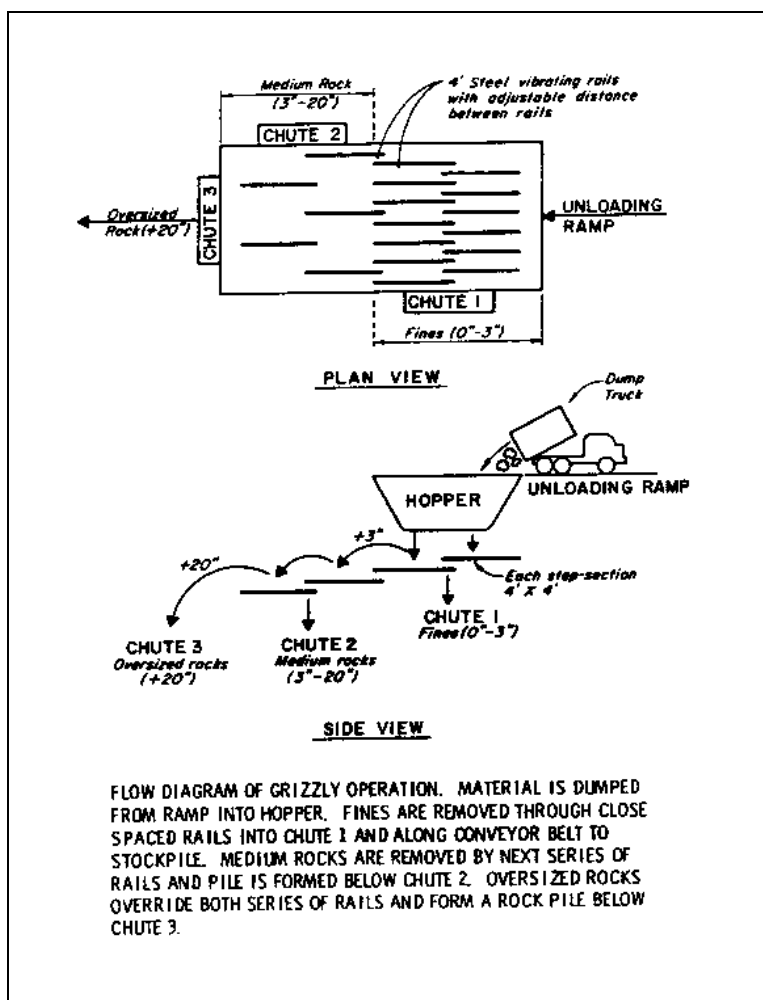

Figure 6-10. Flow diagram of a grizzly operation

Chapter 7 Test Quarry Operations

7-1. Supervision

A major purpose of a test quarry is to determine how rock characteristics and excavation variables affect the rock material produced and how they affect the side slopes and bottom of the excavation. The technical aspects of the test quarry operation are normally best supervised by a geologist experienced in rock excavation methods and procedures. This person, the Technical Test Quarry Supervisor (TTQS) should have sufficient staff to allow complete oversight of the contractor's operations as the work progresses. This work differs from a normal construction contract operation because it is an exploration and testing program with the objective of developing data and procedures to be subsequently incorporated into project design and construction. Numerous variations of excavation procedures, such as ripping and blasting, with its many variables, must be tested to determine what works best in each different rock type. For this reason, considerable flexibility must be written into a test quarry contract to allow the Contracting Officer's Representative (COR) to exercise control of the contractor's excavation procedures, including blast hole sizes, pattern spacing, depth of hole, subdrilling, stemming, type of explosives, powder factor, and loading configuration. Loading and hauling procedures also cause considerable variation in the rock gradation produced and are variables which should be within the control of the COR. A test quarry contract should not be an end-product type but should be a method type and essentially call for the contractor to furnish supervision, labor, materials, equipment, and supplies to proceed with test excavation(s) as directed by the COR.

7-2. Safety Considerations

Safety considerations pertaining to test quarry programs are as follows:

a. Operations. Test quarries are frequently located in areas of very steep terrain where access is very difficult. Rock excavation procedures also require operations which can be very dangerous unless all safety precautions are strictly followed. A safety analysis should be performed before any work begins to establish any added precautions that may be needed beyond those set forth in EM 385-1-1.

b. Affects on test quarry location. Access to the test quarry site is frequently a major problem because of very steep topography and because of the high cost of haul-road construction into such areas. Safety considerations limit the maximum grade to which haul roads may be constructed. Because of access-road cost, the decision is often made to locate the test quarry, not in the area where future construction is to take place, but in one with similar rock types. This may lead to test-quarry and test-fill results which are not totally applicable to the project construction. This can also result in later contractor claims and cost over-runs which are many times greater than if safe access roads to the planned required excavation area were constructed in the first place. If at all possible, the test quarry should be sited within the limits of the excavation area which has been selected as the main source of rock required for project construction. If the costs of doing so exceed the limitations of Preconstruction Engineering and Design funding, consideration should be given to making the test quarry and test fill contract(s) and the access road contract the first construction contract in order to transition from PED to Construction General (CG) funding. This will allow adequate monies to safely construct the test quarry in the most appropriate location(s).

7-3. Modification of Design

As data are obtained during the progress of the test quarry development, it becomes necessary to modify the test quarry design to take into consideration new information about the rock's behavior that was not available at the time of the original design. The test quarry contract specifications should be written to permit these changes at the direction of the COR (as discussed in paragraph 7-1). The test quarry modifications must be developed in full coordination between the TTQS and the designers to assure that all future needs for design information are being met.

7-4. Blasting Plans

Blasting plans should be required by the contract specifications. These are necessary to permit the TTQS to assure that the contractor's plan of operation is in accordance with the test-quarry design. Approval of the blasting plans by the COR should be required by the contract. In addition to the guidance contained in Chapter 5, detailed guidance on blasting techniques is contained in TM 5-332 and EM 1110-2-3800.

a. Master plan. The contract specifications should require the contractor to prepare and submit for review, modification (if necessary), and approval, a master plan of excavation prior to initiation of any excavation. This master plan should include a complete description of the contractor's proposed scheduling sequence, equipment, staffing, overburden removal and disposal/reclamation plans, drainage control, plans for ripping (if required), overall plan for each test blast, and loading and hauling procedures. The plan should also include a description of his provisions for modifications and/or changes to equipment and procedures as required by the COR as excavation progresses and information is developed on which to base such changes.

b. Individual plans. Prior to each blast, the contractor should be required to furnish a detailed blasting plan. This plan should show location of bench to be blasted (with respect to the overall excavation), presplit or smooth blasting plan for side slopes, depth of excavation, burden and free-face location, blast-hole pattern and powder factor, blast-hole diameters, subdrill, stemming, loading configuration, and delay sequence. This plan should be used by the TTQS as the basis to make any modifications deemed necessary to provide the desired breakage data. The contract should require approval of this plan by the COR prior to initiation of the work in the particular test area.

c. Blast reports. The contractor should be required to furnish a post-blast report which will detail any variation that occurred to the individual blasting plan as furnished prior to the blast. Such things as misfires, under or overloaded holes, water in the holes, variations in stemming, and any other observed variables should be reported. Video documentation is helpful in verifying and evaluating blast reports. Test quarry specifications can be written to include video documentation submittals to the TTQS. The TTQS and staff should prepare their own report of each blast. This should contain a description of the rock mass including rock type and condition, as-blasted gradations, condition of slopes, bottom configuration and depth of pull, location of the post-blast rock pile, slope mapping, photographic documentation of the slopes, bottom, and the rock pile before loading and hauling. Report conclusions should include an evaluation of the effectiveness of the blast in providing the design gradation, designed slopes, and bottom conditions. Recommended modifications to subsequent test blasts based on these results should be included in the report.

7-5. Slope Mapping and Presplitting Observations

One of the purposes of a test quarry is to develop blasting procedures which will result in safe, satisfactory permanent slopes. This will require the testing of different presplitting patterns. Different presplit hole spacings should be tested, usually varying from 46 cm (18 in.) to 91 cm (36 in.); different slope angles, usually varying from 1 vertical on 1 horizontal to 1 vertical on 0.25 horizontal; different loading configurations in the blast holes; and different widths of buffer zones between the presplit patterns and the production blast holes. The results of these variables are affected very much by the relationship of the orientation of rock mass structural details to the orientation of the excavation slopes. Slopes cut on one side of the excavation may be entirely satisfactory while those cut on the opposite side may be unsatisfactory and even unstable. Detailed guidance on presplitting techniques is contained in EM 1110-2-3800.

a. Mapping. The excavated slopes should be mapped. The conditions noted and mapped should include cut slope angle, slope height, presplit blast-hole spacing, condition of each slope segment, rock type and condition, and location and orientation of rock fractures intersecting the slope. In addition to mapping rock fractures in the slopes, fracture spacing/frequency should also be noted along judiciously located scan lines for comparison with similar information developed from the design investigations and with the measured rock-pile gradations. Visible groundwater and surficial infiltration seepage areas should also be depicted during mapping.

b. Presplitting observations. Each slope should be carefully described and reported as to its condition, taking into account the results of the presplitting and those factors such as intersecting rock fractures and rock quality which affect the stability of the slope. The maintenance of design blast-hole spacing and orientation is very important. Where these deviate from design, the results should be described. Successful presplitting normally leaves a half-round of the individual blast hole visible in the slope. Where these are not seen, it is likely that the presplit shot was too heavily loaded or that there was an insufficient buffer zone between the production blast and the presplit slope. If the presplit plane between blast holes is highly irregular, it is likely that the hole spacing was wider than optimum. Excessive rock fracturing behind the permanent slope line is another indication of excessive hole loading.

By contrast, incomplete shearing of the rock between presplit holes may be an indication that the holes were under loaded or that they were too widely spaced. Rock structure induced (wedge or planar) slope failures may occur. These features should be incorporated into the slope maps and should be described for inclusion in the final report. Complete photo coverage of the as-excavated slopes is of considerable value in illustrating the observation descriptions. These photographs should be obtained after the slope is freshly cut and used generously in the final report.

7-6. Rock Quality and Pre-Test Fill Gradations

a. Rock quality after blast. It is important to evaluate and describe the quality of the blasted rock existing in each blasted area. Rock quality is a major factor of the design of rockfill structures and it is important to compare the rock quality observed from the test quarry program with the design assumptions. In addition, variations in rock quality often become the basis for disputes between the contractor and the government. Because of the uniqueness of each site and each rock type, rock quality evaluation systems should be designed on the conditions encountered in each test quarry program. Such evaluation systems should include, as a minimum: rock type, degree of weathering (unweathered, slightly weathered, moderately weathered, highly weathered, decomposed, EM 1110-1-1804), potential for degradation, both in stock piles and during fill placement and compaction (e.g., estimates of abrasion resistance, desiccation deterioration, incipient fractures, brittleness, softness, and physical or chemical instability), and rock mass gradation.

b. Pretest fill gradations. As part of the rock mass quality evaluation, it is important to develop information on the degree of degradation that occurs during the loading, hauling, processing, storage, and placement of rock fill in an embankment. In order to obtain this information, it is necessary to determine the gradations that exist after blasting but before loading, hauling, placement, and compaction. This should be done by the same procedures which will be used to control the gradation of fill placed in the test fills and subsequently in the embankment. Methods for obtaining mechanical gradations of rock fill were addressed in paragraph 6-5 and will be treated in more detail in Part 2: Test Fills. In addition to the mechanical grading methods, particle size scan-line measurements of the blasted rock pile should be performed and their accuracy evaluated. If particle shape and percentage of fines allow these types of measurements, they are a rapid, economical adjunct to time-consuming screen gradation measurements. A comparison of the initial rock

mass gradation with gradations made at subsequent stages in the process of rock placement in test fills will provide data on which to base an appraisal of rock mass degradation that can be expected during loading, hauling, and embankment construction. If there is potential for the rock to deteriorate over time in a stock pile, this too should be evaluated. One approach is to establish test stock piles and perform initial and subsequent gradation tests and compare the results. A complication can develop in this test because the mechanical action of the test itself may tend to degrade the particles of the test specimen. This must be considered in evaluating the results. Hairline blast fractures develop in some brittle rock types. Because these fractures allow degradation of particle size during handling, processing, placement, compaction, and project operation, they need to be identified during this stage of test quarry development. Samples of varying particle size should be furnished to the appropriate Division Laboratory for testing to determine the presence of minute blast-induced fractures.

7-7. Rock Processing Results

Frequently, rockfill embankment designs require rock processing that goes beyond the quarry-run gradations that can be produced by the rock excavation procedures in the quarry. These can include simply processing the rock over a grizzly to separate it into two or three different sizes to the much more complex process of running the rock through a crusher and vibrating screens to produce a series of carefully controlled gradations. The more processing required, the more expensive the embankment construction will likely be. In addition, it is likely that there will be more opportunity for disputes between the contractor and government. If the design efforts indicate that processing will be required during construction, it is important to test it during the test-quarry and test-fill operations. Otherwise, the results from the test quarry and test fill may not be indicative of the results to be obtained during final construction. The gradations obtained from rock processing are the results of many variables. These include rock type, rock quality, excavation method, and rock crushing and screening plant design. It is frequently difficult for a smaller test quarry and portable processing equipment to reproduce the results that will be obtained from a full quarry and large production equipment. For these and other reasons, it is desirable to design the embankment to require as little processing as is possible and to construct the test fills with materials that are truly representative of those that will be obtained from the construction production excavations. Rock processing results should be carefully described in the Test Quarry and Test Fill Report.

7-8. Report

The data and information developed during the test quarry construction should be analyzed, evaluated, and reported in a Test Quarry and Test Fill Report. The test quarry portion of the report should contain sketches of each test blast, maps of all excavated slopes and bottoms, descriptions of the results of each test blast including presplit slopes, gradations of the quarry-run material produced by each blast in each separate rock type, and conclusions and recommendations. The report should be generously illustrated with geologic maps and cross sections, sketches, photographs, analyses of the rock fracture orientations and frequency/spacing revealed in the excavations and evaluations of the fracture orientation and spacing to slope stability to the blasted rock gradations produced. A typical outline of the test quarry section of the report is shown in

Table 7-1. The report of the test quarry program is a very important document for use during final design and construction. Also, it can prove to be very valuable during the contract disputes which inevitably arise during the complicated construction of a large dam. The importance of a complete, accurate, well-conceived report cannot be overemphasized. The conclusions and recommendations section of the report should be specific with regard to the suitability of the rock materials for the uses to which it will be placed. Constraints upon the suitability of the materials must be clearly stated (e.g., shale partings in a rock mass will likely lead to an eventual breakdown in particle size). Recommendations for any special handling, processing, storage or placement methods that were developed during the test quarry operation should be clearly detailed in that section of the report.

Table 7-1
Typical Test Quarry Report Outline

1. Executive Summary
2. Introduction
3. Test Quarry Design and Objectives
 - a. Discussion of objectives
 - b. Overview of site selection criteria
 - c. Thorough presentation of design including layout and slope stability
4. Geological Conditions in the Test Quarry
5. Description of Each Test Blast
 - a. Rock type and condition
 - b. Hole pattern
 - c. Delay pattern
 - d. Hole depths and loading design
 - e. Explosives, detonators, and delays
 - f. Blasted rock mass description
 - g. Quarry-run gradation
 - h. Laboratory test results
 - i. Conclusions
6. Drilling, Loading, and Hauling Equipment and Procedures
7. Description of the Results of Each Presplit Slope Blast
 - a. Rock type and condition
 - b. Presplit hole and explosive charge configuration
 - c. Presplit slope condition
 - d. Rock joint analysis and slope stability
 - e. Conclusions
8. Rock Processing Results
 - a. Description of processing objectives
 - b. Description of rock processing equipment
 - c. Results of processing each rock type and condition
 - d. Gradations and particle shapes
 - e. Degradation during each stage of processing
 - f. Laboratory test results
9. Conclusions and Recommendations
 - a. Conclusions including lessons learned
 - b. Recommendations

APPENDICES -- Laboratory Test Sheets, Boring Logs, Field Gradation Test Results, Description of Rock Processing Equipment, Photographic Documentation, Etc.

PART 2
TEST FILLS

Chapter 8 General Considerations

8-1. Background

The earliest rockfill dams in the U.S. were built in the southwest and west just before the turn of the century (Wegmann 1899). Most were of loosely dumped quarried rock with some version of core or upstream facing including wooden planking, concrete, or hand-placed rock dry-wall. From thence up until the 1950's, the design and construction of rockfill dams were a matter of empiricism. Construction was by end-dumping over high slopes with water sluicing in 18- to 61- m (60- to 200-ft) lifts. The sluicing with water jets was intended to displace fines from between the larger particles to produce rock-to-rock contact among the larger particles and reduce the compressibility of the mass. However, the technique still produced rockfill which was relatively compressible and subject to considerable post-construction volume change. The transition to compacted rockfill for both earth-core and concrete-face dams occurred during the period 1955-1965 (Cooke 1984) as shown in Figure 8-1 (Cooke 1990). This transition was possible because of the advent of heavy vibratory rollers and was particularly spurred by Terzaghi's criticism of dumped rockfill for its excessive compressibility and his recommendation of compacted rockfill in thin lifts as a means of greatly reducing it and also allowing the use of poorer quality rock (Cooke 1960). In the United States, the 136-m-high (445-ft), Corps of Engineers Cougar Dam (completed in 1964) was the first major earth and rockfill structure in which vibratory rollers were used to compact the rock shells (Bertram 1973). At the time of the construction of Cougar Dam there existed practically no information about the construction and evaluation of compacted rockfill so that trial and error test-fill procedures were used as the work progressed. It is interesting to note that Terzaghi had stated earlier that it would be impossible to determine the properties of rockfill in the laboratory and that only experimental fills should be used for such purposes. Even the most recent literature (NATO 1991), though filled with laboratory and model study information on rockfill properties and behavior, still confirms a continued reliance on test fills. Notwithstanding that statement, it can also be said that, in overview of the significant experience gained and common current practices concerning rockfill, test fills may sometimes be in wider use than actually necessary. In the remaining portion of this Part of the manual, test fill will be spoken of in the singular but it is not at all uncommon that more than one test fill may be needed. The reader should have

no difficulty in recognizing the aspects of that to follow which may dictate more than one fill.

8-2. Why a Test Fill?

The main properties of interest of compacted rockfill fall under or relate to, shear strength, compressibility, permeability, and suitability of compaction equipment. Because of the fundamental nature of rockfill being cohesionless and containing large particles, it is not feasible, nor is it possible to obtain or test large "undisturbed" samples to determine the pertinent properties. Furthermore, the typical three-dimensional heterogeneity of rockfill and the densities typically obtained from field compaction cannot be replicated in reconstituted laboratory specimens in those limited cases where very large laboratory testing equipment of high load capacity is available. Laboratory studies of rockfill properties have been conducted on gradations containing smaller maximum particle sizes than most often actually placed and have, therefore, been more akin to parameter studies to provide insights on effects of variations in those parameters and to provide educated estimates of full-scale gradation behavior. In specific case histories, such data can be applied in numerical analyses coupled with observed embankment behavior to assess the quality of the laboratory results for predictive purposes but the state of that art should probably be considered to be in a state of relative infancy. Even the more frequently performed versions of maximum density tests have usually involved altered gradations (scalped) or modelled gradations (scalped/replaced or parallel) with significantly smaller maximum particle sizes. The profession has not thoroughly established the effects of such practices on the numbers yielded in comparison with full-scale materials. Test fills have then often been the basis for determining traits of the compacted rock which have led to completely satisfactory dam embankments including the very highest yet constructed. If the rock is of high compressive strength (sound rock), test fills may not even be necessary or adequate placement and compaction procedures can be determined in the early stage of construction without elaborate test fill operations. In this case, the only tests needed are drill core samples and saturated unconfined compressive tests which are among those previously mentioned in Part 1. Cooke further states that for sound rock, four passes of a 9.1-Mg (10-ton) vibratory roller upon layer thicknesses averaging about 1 m (3.3 ft) have become standard practices. Heavier rollers have not been found to usually offer any advantages. Since permissible maximum particle size for sound rock can be equal to the lift thickness if the proper placement method is used (to be discussed later), the most efficient

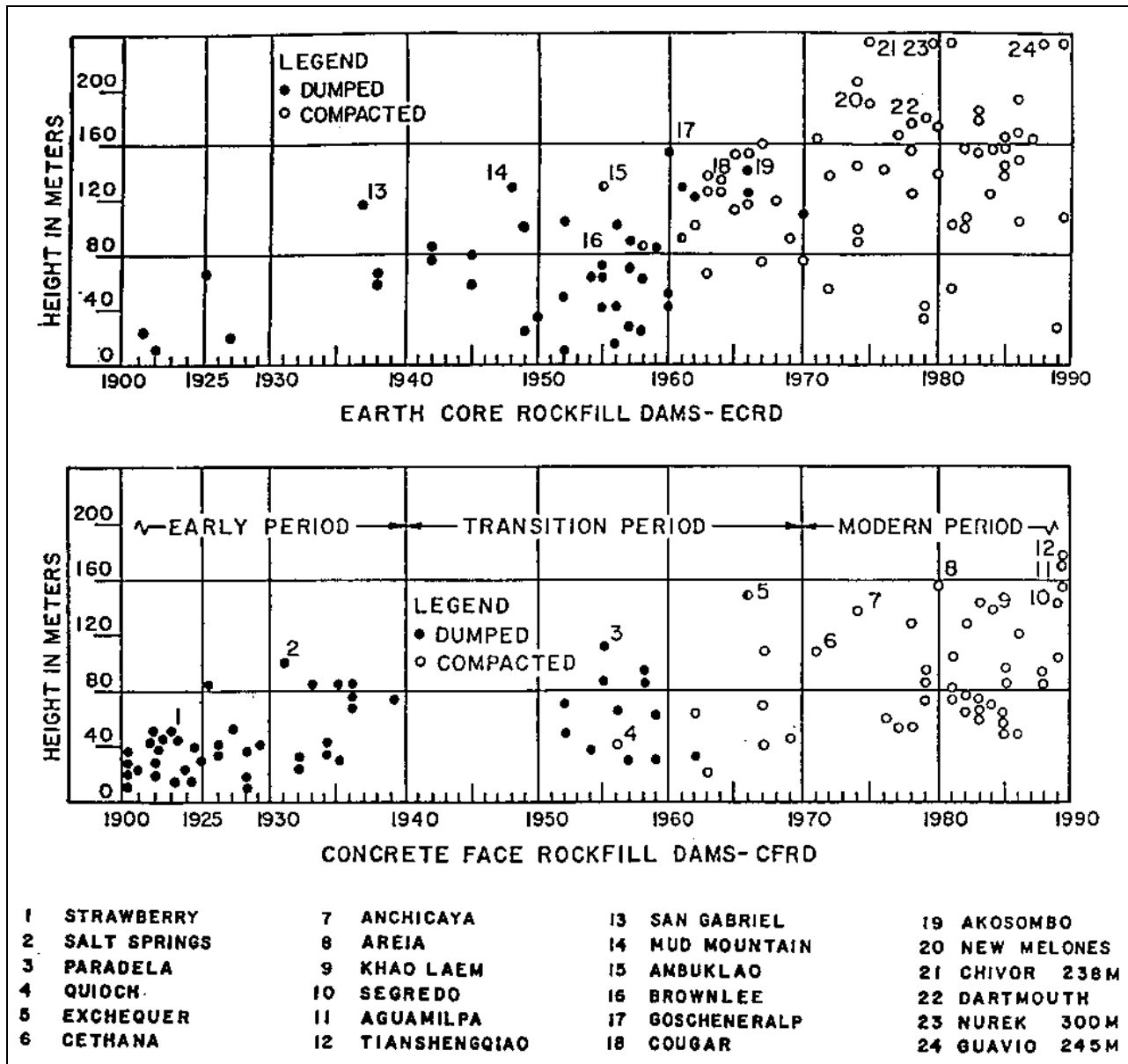

Figure 8-1. Transition in practice from dumped rockfill to compacted rockfill (after Cooke 1990)

quarrying operations determined from the test quarry may essentially dictate the lift thickness. If the available rock material is of low compressive strength (say, less than 55×10^6 Pa or 8000 psi), a test fill program is typically necessary. It has been previously stated in Part 1 that for softer rock types or conditions, degradation of the material from the quarry through all aspects of its handling including loading, processing (if employed), hauling, stockpiling (if employed), placement, and compaction (whatever the combinations of lift and equipment) cannot be confidently predicted by even the most experienced individuals much less the best placement/compaction

procedures. Indeed, the question sometimes exists as to whether the material will ultimately be a free-draining rockfill after compaction or whether it will have degraded or must be made to degrade (because it will do so eventually postconstruction) into a soil material and treated as such in all aspects of design, construction, and construction control. An example of material which may appear to be a rock upon quarrying but will deteriorate into a soil upon wetting (whether stockpiled or compacted in the embankment) with time are certain shales (Lutton 1977). In planning and conducting a test fill program, it should be kept in mind that it can also offer considerable

advantages in optimizing design and providing project construction personnel with the opportunity to familiarize themselves with materials and construction procedures.

8-3. Representative Procedures

A most important consideration for any test fill program is that procedures employed in constructing the test fill must simulate, as closely as possible, feasible construction procedures to be used in the project fill. The achievement of this imperative objective requires some experience in the construction of rockfill. If test-fill procedures do not closely simulate actual construction, the value of the test-fill investment is compromised and the effort may even do more harm than good. If experience in rockfill construction and its sampling/testing is seriously lacking, the use of a test fill as a preconstruction training exercise for project personnel may be a justified investment for sound rock and a natural advantage of test fill programs usually required for softer materials.

8-4. Test-Fill Scheduling

It has been by far the greatest preference to conduct test fills before construction begins (i.e., at some time during the project design stage) but there have also been cases of provisions made in the bid documents to allow for their construction during the early phases of actual construction. If the latter approach is under serious consideration, it must be based on very substantial confidence that the

items to be determined from the test fill have no potential of altering the design of the embankment or of rejecting the basic adequacy of the available materials. On the other hand, the advantages of a prebid test fill include: results can be used by the designer to prepare specifications for rock placement and compaction (and blasting/processing if a test quarry is also conducted), the quarry face can be inspected by prospective bidders, and construction personnel can be trained for adequate visual observation skills and required testing procedures. Therefore, a properly conducted prebid test fill program will most likely result in a lower bid. A prebid fill would naturally be scheduled to start at a point in the iterative-step development of the test quarry such that gradations produced in the test quarry and available for the test fill construction are deemed to be those recommended for project construction. The decision of when to conduct a test fill, then, is one which must be based on features of the individual project.

8-5. Flexibility

A test fill program must be flexible. Because of natural rock variations and unpredictable behavioral characteristics, it is often impossible to lay out a definite program in advance from which there will be no deviations. Procedures and envisioned specifications have often been altered based on results of completed portions of an original program. The test fill program designers must anticipate that possibility.

Chapter 9 Planning and Design

9-1. General

Planning and design of a test fill program should be done with care to consider all the facets of the objectives of such a typically expensive investment. The proposed program should be thoroughly reviewed to assure that all procedures and tests are properly designated and planned in the order of the work. There is no better guidance available for laying out a program than to review those programs conducted by others, particularly for Corps of Engineer projects. This manual cannot substitute for the careful review of the details of procedures and findings to be found in the reports of test fills and test quarries for previous projects. As was suggested for a test quarry program, it is highly desirable that one individual be charged with responsibility in the field for conduct of the test fill and for dealings with the contractor.

9-2. Location of the Test Fill

The test fill should be located as near the test quarry or rock source as possible. This will obviously provide an economy of operation. If multiple test quarries are to be developed and multiple test fills associated with their yields, the siting considerations include the decision of multiple test-fill sites or a single larger site. The use of a stockpile between the test quarry and test fill operations depends upon the expected project construction operations. It has already been pointed out that stockpiling may produce changes in the rock gradations reaching the fill if for no other reason than the double-handling (loading and hauling). If stockpiling is not anticipated in the project construction, it should be avoided in the test-fill program if possible. If stockpiling is expected to be required in project construction, its effects should be assessed in the test-fill program. The test-fill site should be as level and of sufficient area to accommodate the test fill itself plus ample peripheral space to permit full equipment mobility. The site should be graded to provide good drainage.

9-3. Geometry

The geometry of the test fill configuration depends on the objectives and the variability and availability of the rock to be tested, not to mention constraints imposed by cost. In addition, there is considerable latitude deriving from individual preferences. It then becomes practical herein to only discuss test-fill geometry in the more general

sense. The test fill should be of sufficient size to allow its performance to be as close to project fill behavior as possible. This means that the effects of scale should be minimized. Widths and lengths of individual test sections should be of sufficient magnitude so that settlement readings (discussed later) reflect densification from compactive effort alone and do not reflect lateral bulging of the fill. In most cases, a width of 10 to 15 m (about 30 to 50 ft) with a length at least equal to the width but 6 to 10 m (about 20 to 30 ft) longer, if feasible. The individual fill sections may abut each other longitudinally or be laid out in a parallel configuration with ramps on each end at slopes of 1 vertical on 5 horizontal or flatter to facilitate equipment entrance and exit. Maximum side slopes of 1 vertical to 1.5 horizontal are recommended. The ramps and side slopes may be constructed of quarry-run materials. Four or five layers (lifts) are usually sufficient to provide enough data to establish the compaction specifications for any one type of rock. Figures 9-1 through 9-10 provide examples of test fill geometries used for several Corps of Engineers dam projects.

9-4. Test Sections or Lanes

In the most ideal case allowing the easiest separation of variables, an individual test section or lane of a test fill should not contain different materials or be composed of different lift thicknesses, lifts compacted by different equipment, or a different number of passes applied to succeeding lifts. For example, suppose it is desired to evaluate 46- and 91-cm (18- and 36-in.) lifts. It would be more desirable to use two fill sections, one containing 46-cm (18-in.) lifts only and the other 91-cm (36-in.) lifts only, rather than one section containing lifts of both thicknesses (e.g., four to five 46-cm (18-in.) lifts over four or five 91-cm (36-in.) lifts). There have been cases where groups of different lift thickness were employed successfully in the same section with increasing lift thickness from bottom to top of the section as shown for Seven Oaks Dam in Figure 9-10. The use of the transition from thinner to thicker lifts from the base upward at least diminishes the effects of additional settlement of the lower lifts being included in with the measurements assessing the compaction applied to the upper, thicker ones. However, the Seven Oaks test program heavily relied on large-scale density tests taken in each lift after intermediate roller passes to assess compaction rather than strictly relying on surface settlement readings. In other cases of a single test section incorporating more than one lift thickness, measures were taken to eliminate the continued settlements of lower, thinner lifts from entering into the settlement readings for the upper lifts. This was

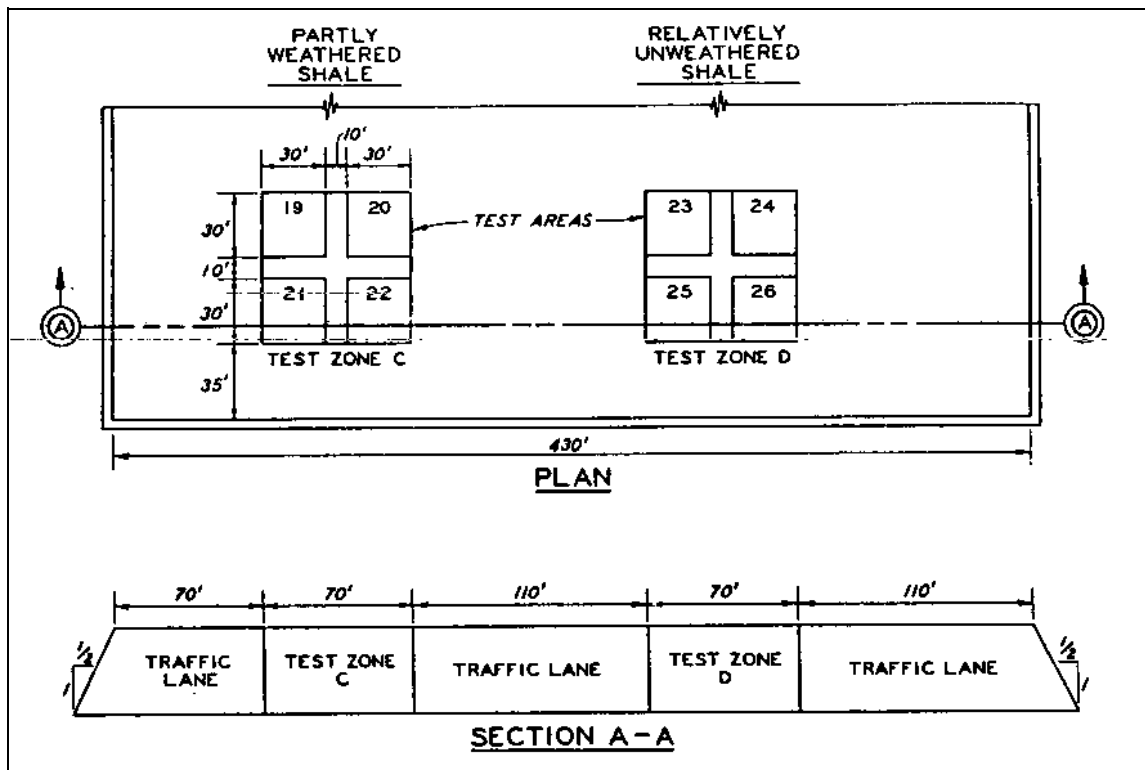

Figure 9-1. Beltzville Dam, plan and profile of the test fill

accomplished by either (a) rolling the last lower and thinner lift until no further settlement was seen before placing the upper, thicker lifts, or (b) installing settlement plates on the surface of the last, lower, thinner lift in order to subtract additional settlement from that observed for the upper lifts. The former method of “proof” rolling the lower lifts may completely alter that material with respect to its condition after a reasonable number of roller passes to be used in the project and compromise any observations from an inspection trench excavated after completion of the test fill. The use of settlement plates with stems up through additional thicker lifts poses troublesome obstructions in the placement and rolling of those lifts and may compromise their similarity to project conditions. In any case, enough lifts (four or five) of the same thickness must be used so that a good average settlement curve can be obtained for all like lifts in each zone.

9-5. Equipment

Generally, loading and hauling equipment should be used that will result in the most efficient operation and which is likely to be used for the project construction.

Front-end loaders can be used to load the quarried rock into trucks for hauling to a processor or to the test fill. A loader is more maneuverable than a power shovel and less costly on small operations. Crawler tractors are the standard equipment for spreading materials to the desired loose lift thickness and in many cases of medium to soft rock have also proven capable of breaking down oversized pieces delivered to the test fill. In special cases (i.e., not very frequently), where crawler tractors have been seen to produce excessive degrading of the material, rubber-tired equipment has been used for spreading. For material which does not degrade through the compaction operation to the extent that it must be considered a soil, 9.1-Mg (10-ton) or 13.6-Mg (15-ton) vibratory rollers are the most common choices. For materials which are friable or weathered material which will degrade into an obvious soil during hauling, placement, and compaction, heavier vibratory, pneumatic, or tamping rollers may be required. For materials which arrive at the test fill or are broken down in spreading and compaction into a mixture of rock and soil, the means of determining whether they remain suitable for rockfill or must be treated as a soil in design, construction, and construction control will be addressed in Chapter 10.

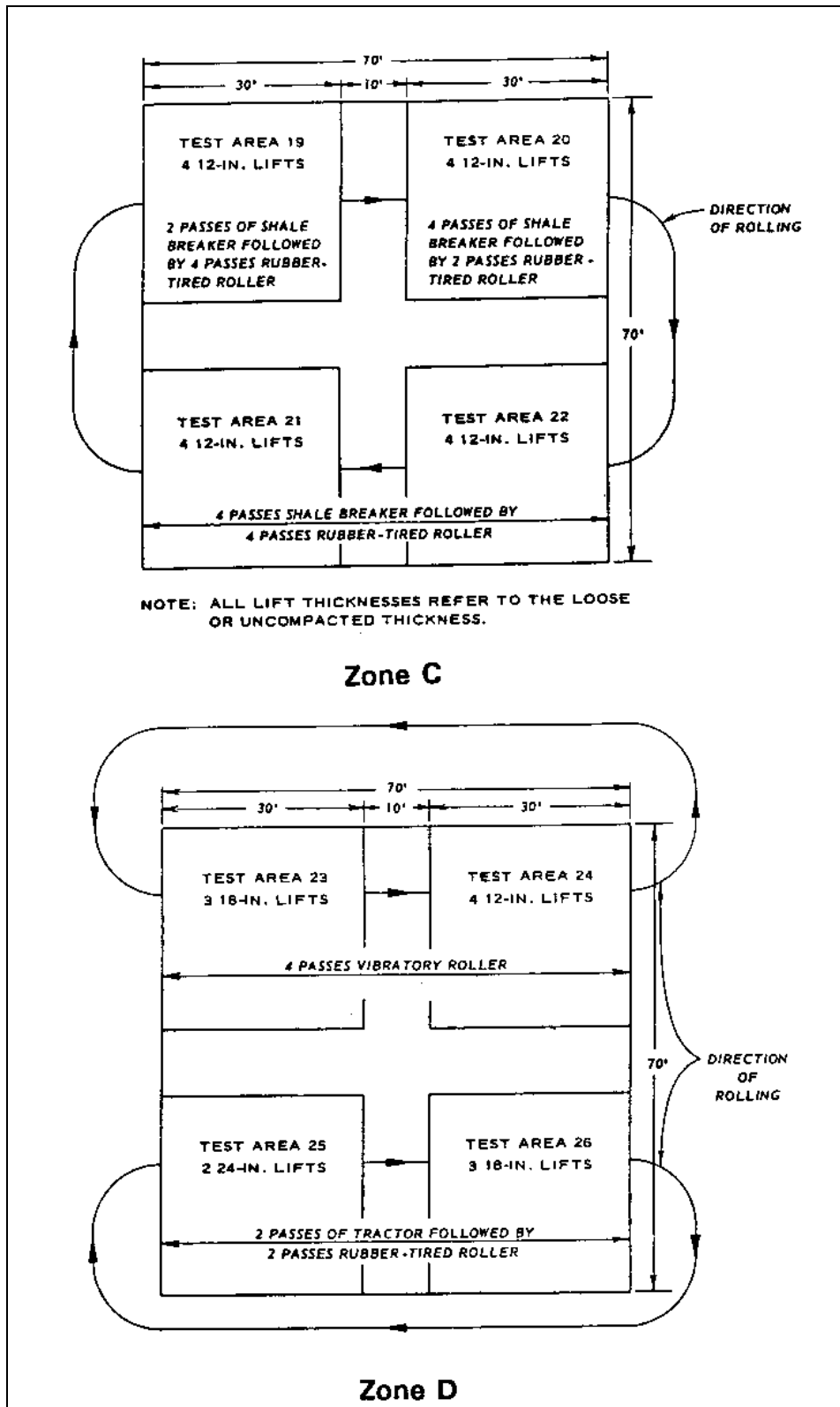

Figure 9-2. Beltville Dam, plan view of the rolling pattern

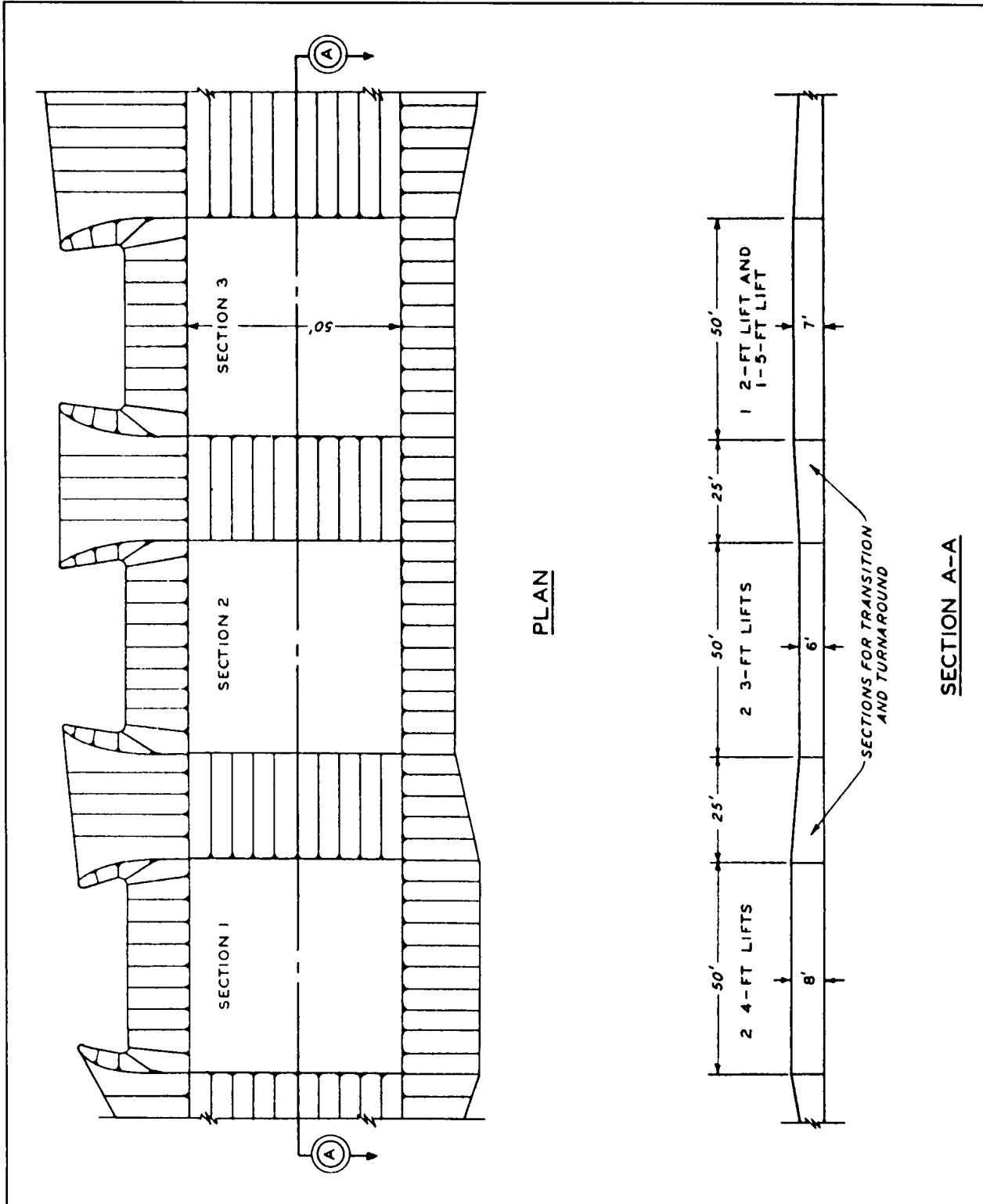

Figure 9-3. Laurel Dam, plan and profile of the test fill

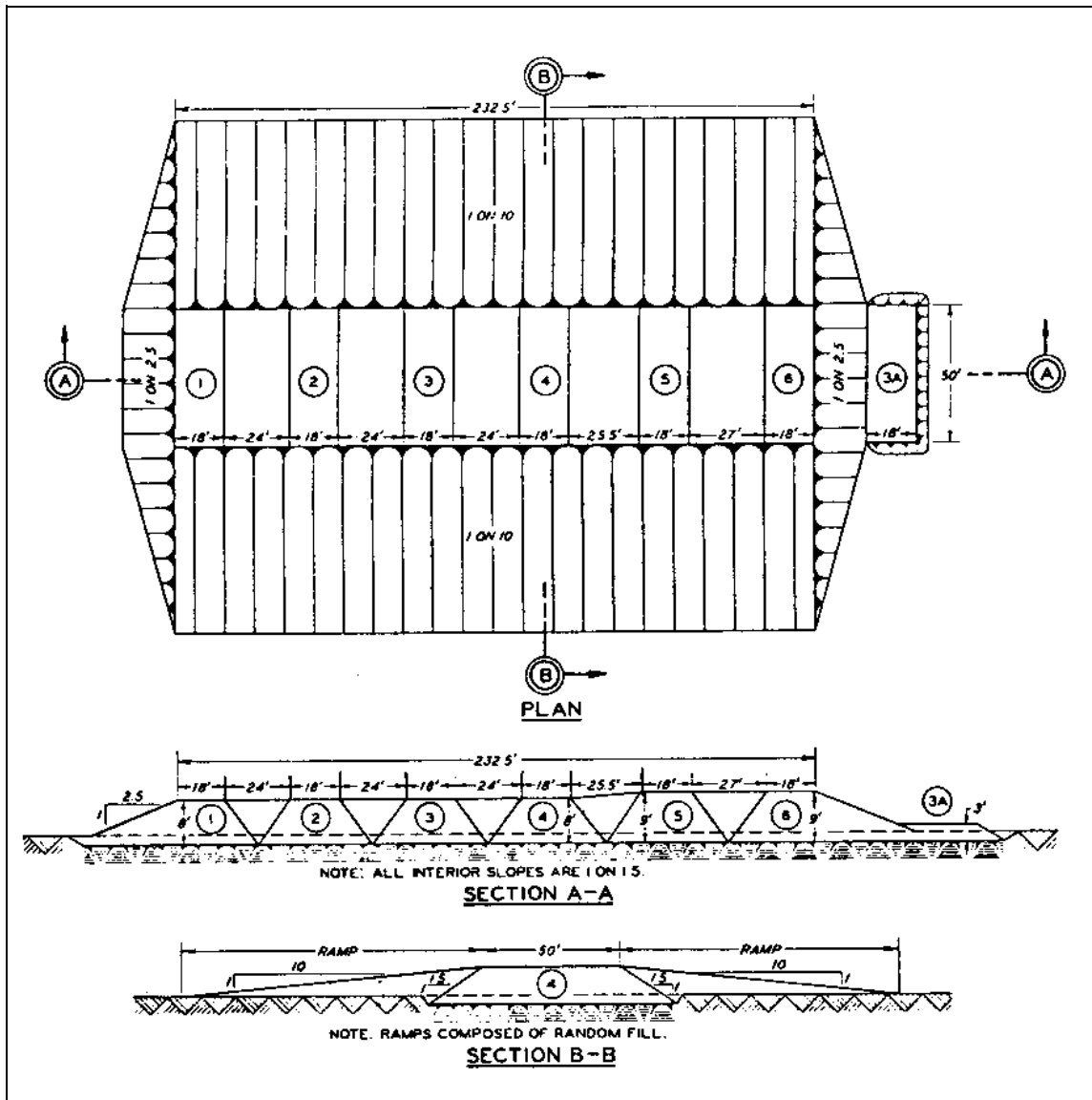

Figure 9-4. Gilham Dam, plan and profiles of the test fill

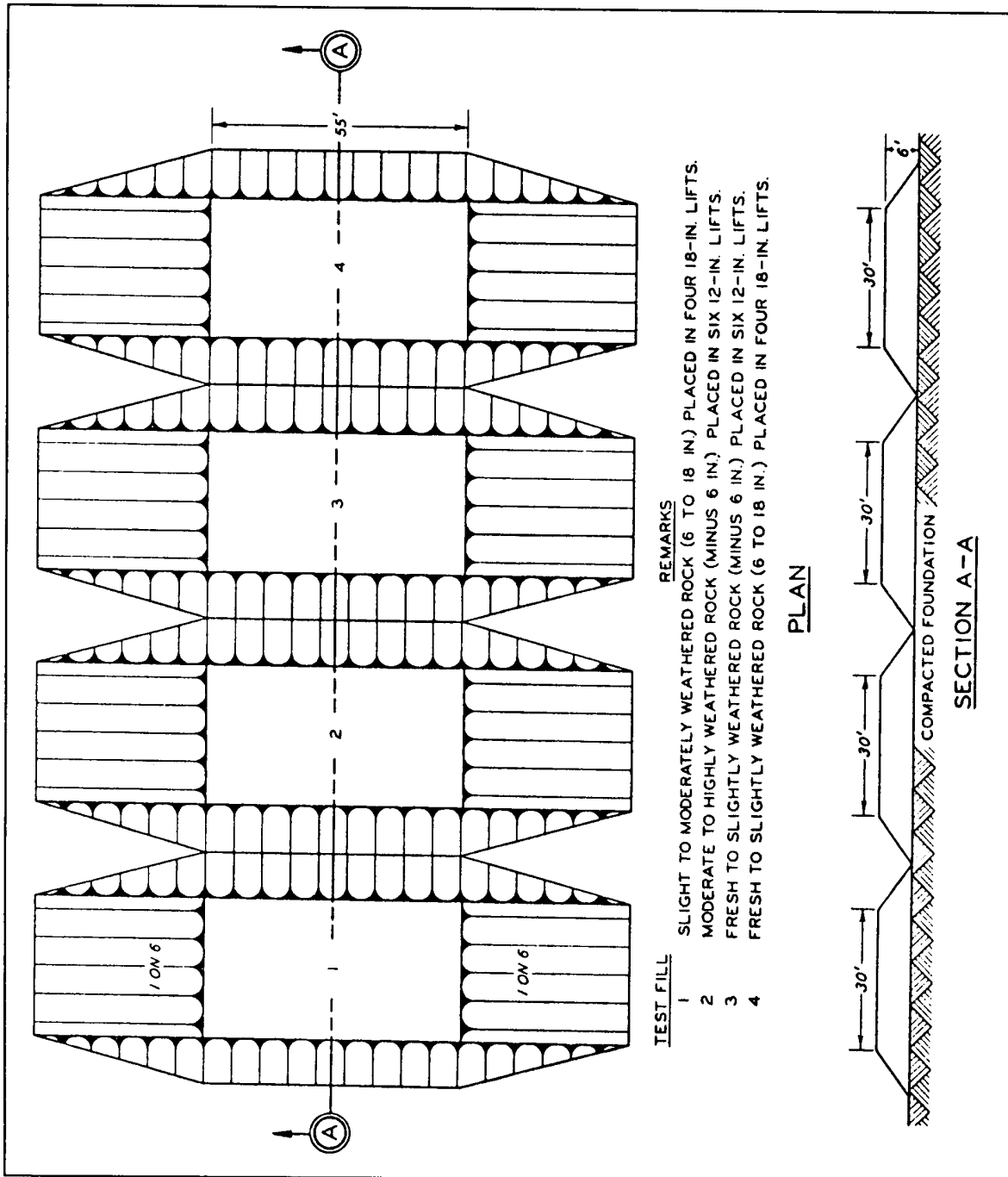

Figure 9-5. New Melones Dam, plan and profile of the test fill

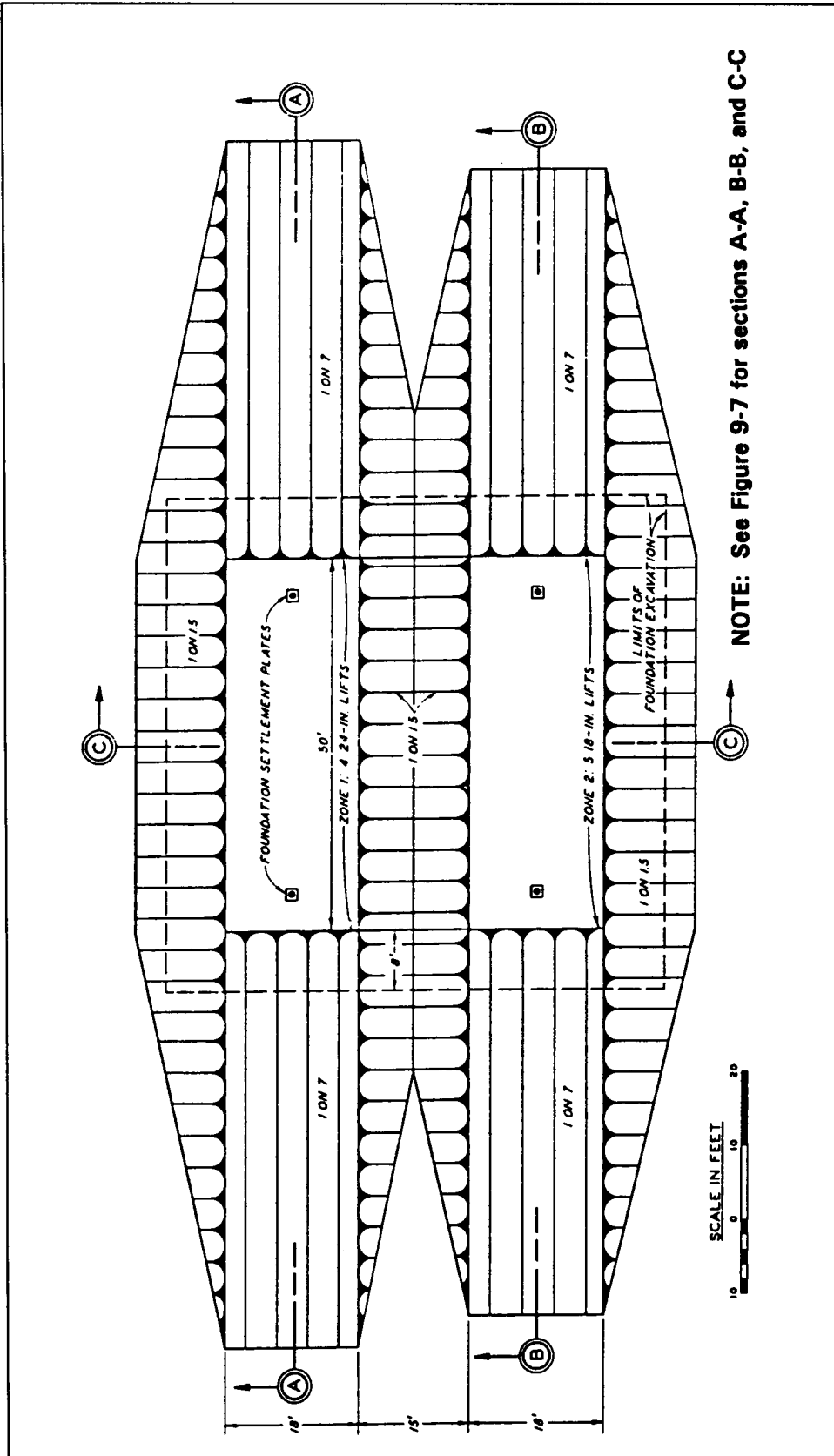

Figure 9-6. Gathright Dam, plan view of the test fill

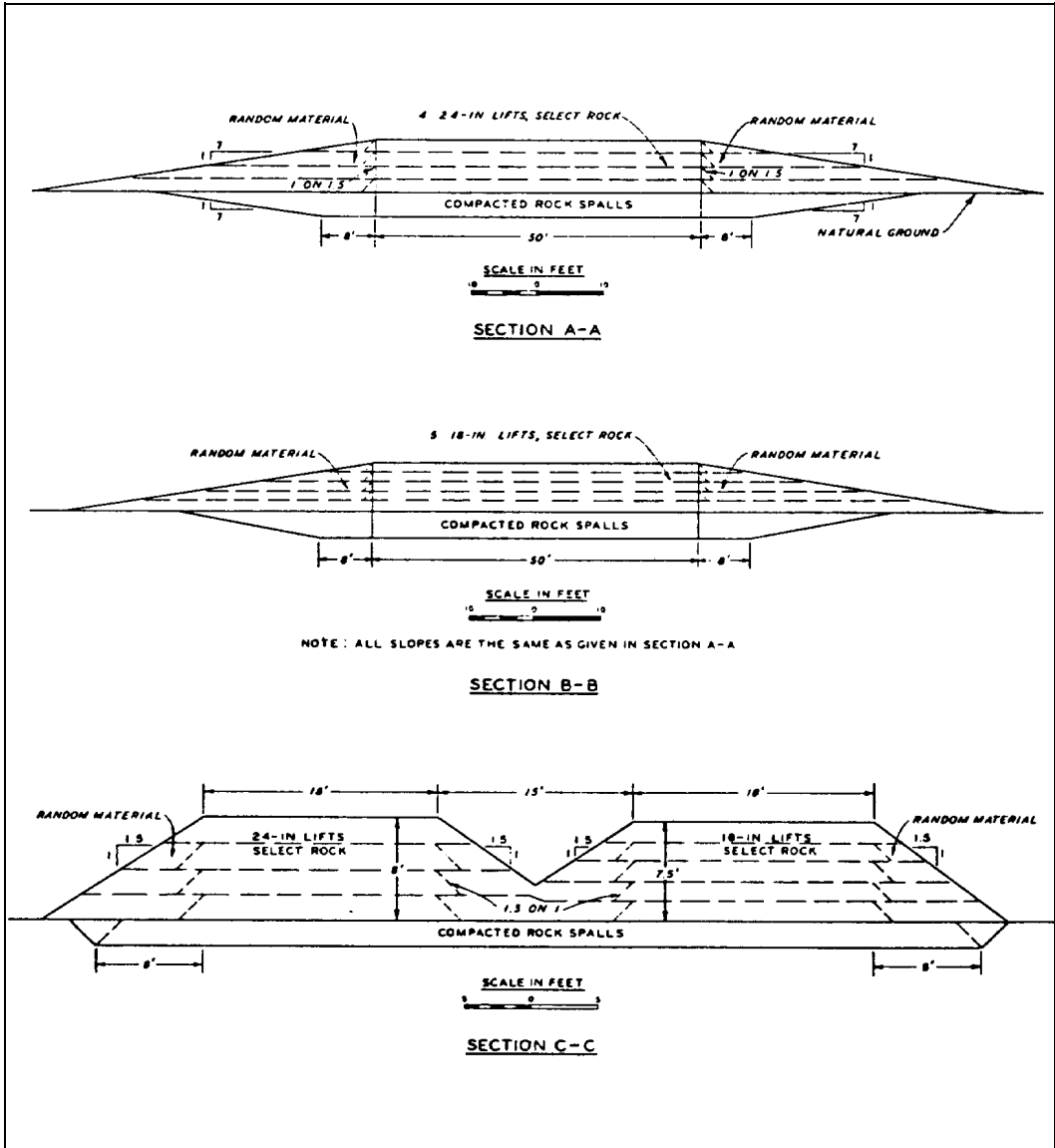

Figure 9-7. Gathright Dam, profiles of the test fills

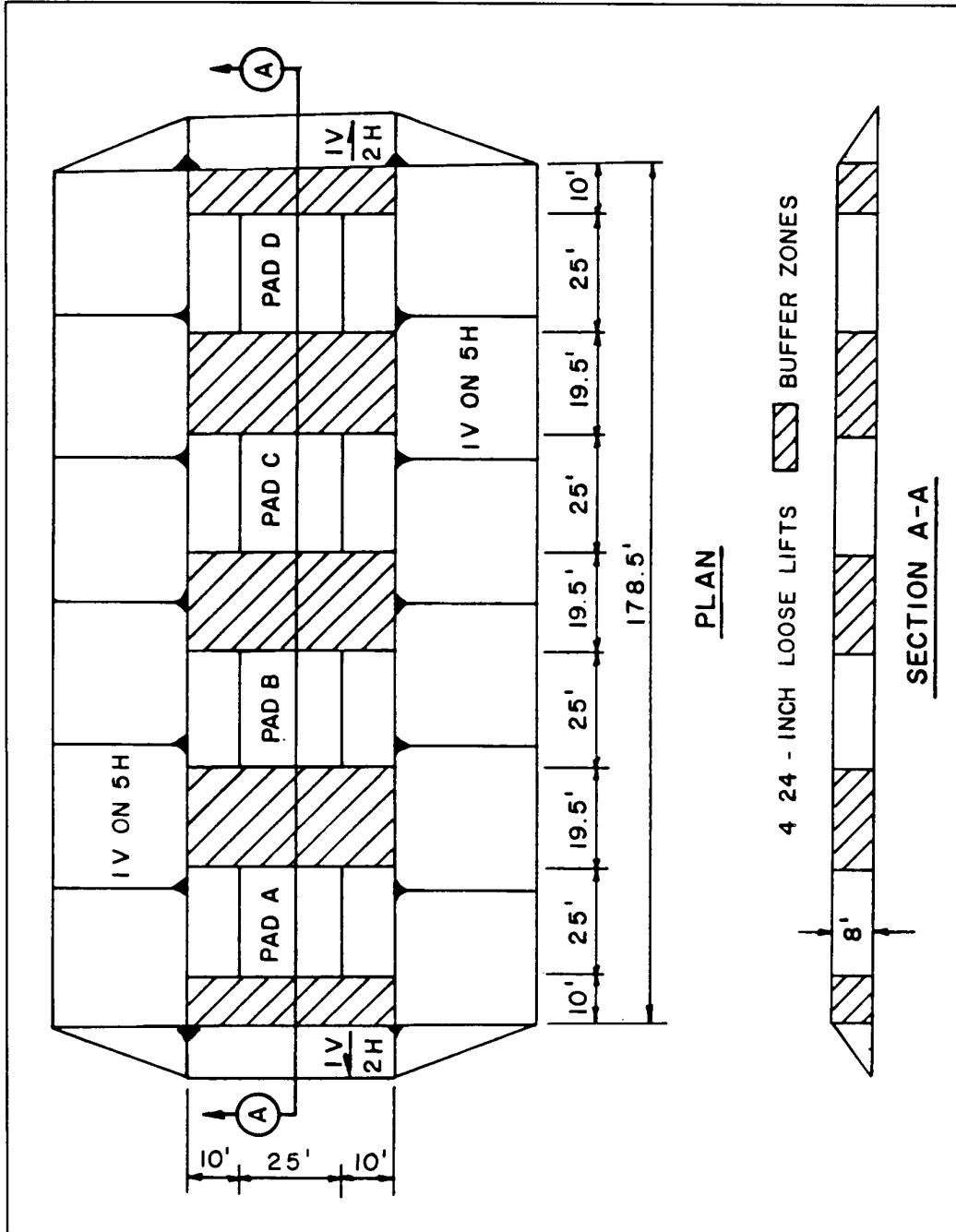
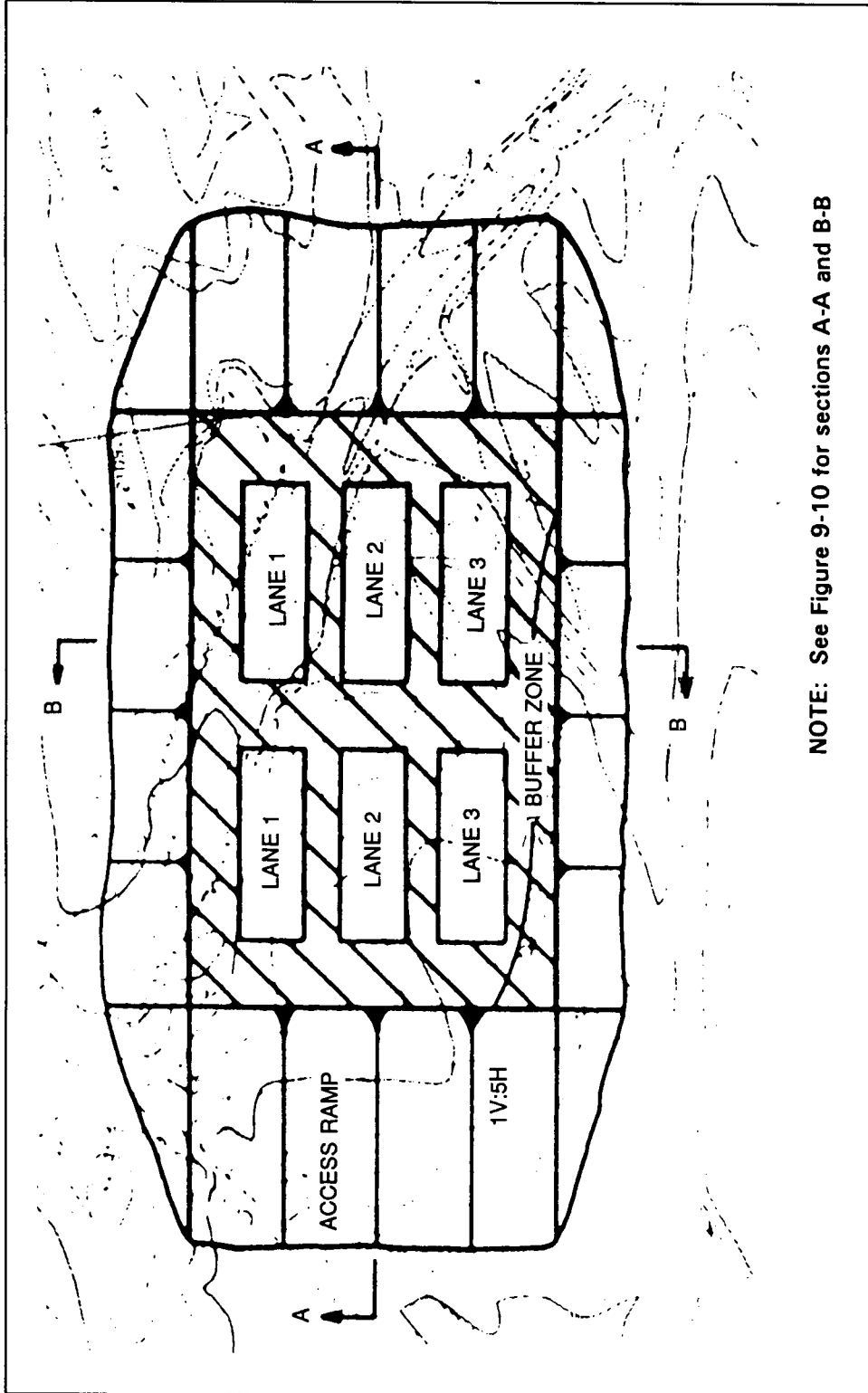

Figure 9-8. Cerillos Dam, plan and profile of test fill No. 3



NOTE: See Figure 9-10 for sections A-A and B-B

Figure 9-9. Seven Oaks Dam, plan view of the test fill

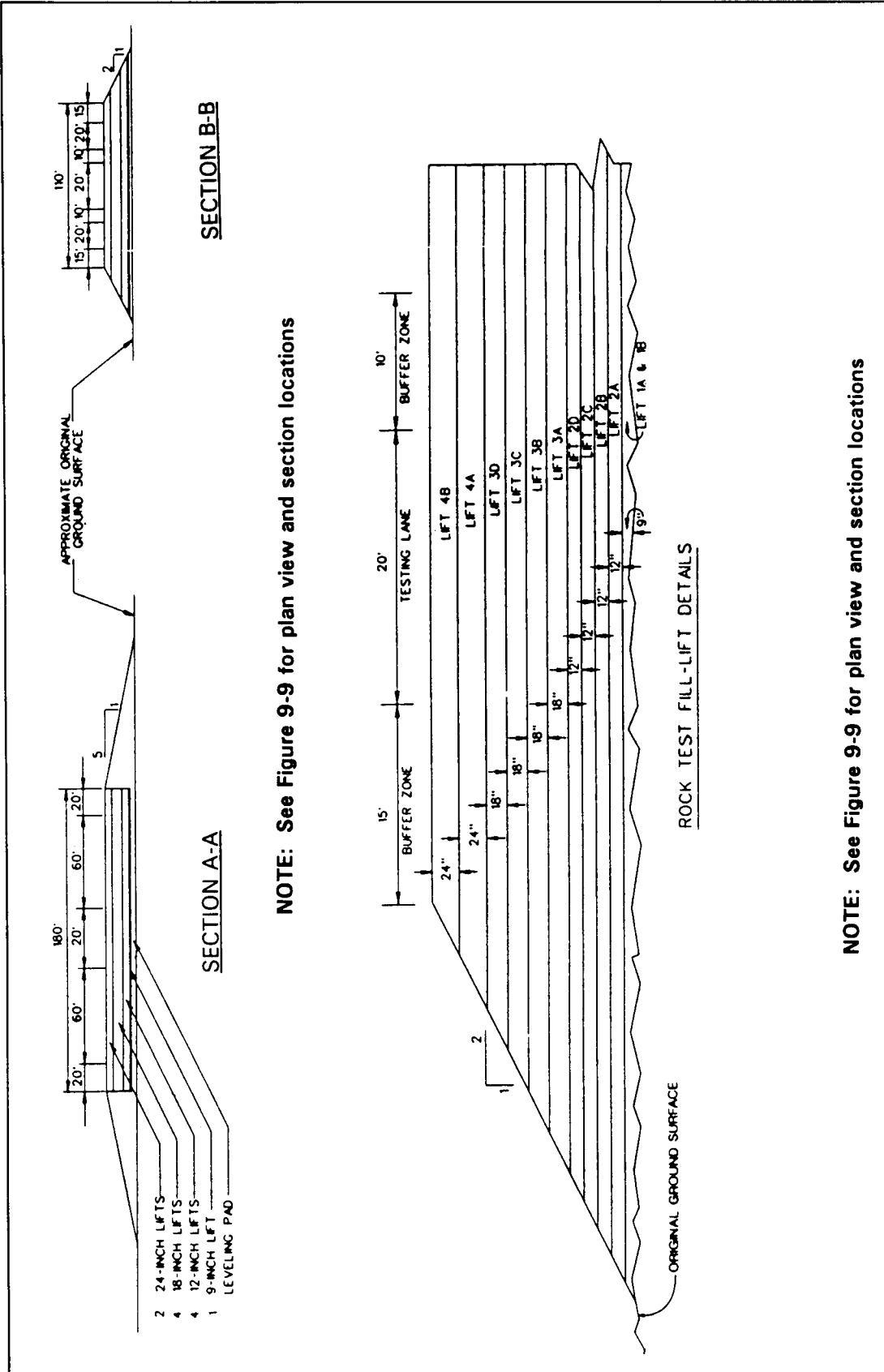

Figure 9-10. Seven Oaks Dam, profiles of the test fill

Chapter 10 Test Fill Construction

10-1. Foundation Preparation

The proper preparation of the foundation for a test fill is of special importance since settlement readings on the surface of the lifts rather than in situ density tests are commonly used to evaluate the relative compaction obtained. Fortunately, in areas near quarry sites, rock foundations can usually be provided with a minimum of overburden stripping. If, however, the foundation consists of soil or weathered rock, it must be thoroughly compacted prior to fill placement, preferably until no further significant settlement can be observed. Although undesirable, where further consolidation of a compressible foundation under fill loads is possible, settlement plates should be installed in the foundation to provide data needed to correct the test fill settlement readings. If foundation settlement plates are needed, the considerations of test-fill layout should include the feasibility of locating those plates between and about test lanes in a manner which would allow sufficiently accurate determination of average foundation settlement and avoid the obstructions of plate risers in the placement and rolling of the fill. Guidance concerning use of settlement plates (see Figure 10-1) is provided in EM 1110-2-1908. A thoroughly compacted rock pad (or leveling course), 61 to 91 cm (2 to 3 ft) thick, should be placed on the foundation (whether soil or rock) prior to placing the first test lift in order to ensure that all foundation depressions and undulations are filled and a level surface is obtained. Material for the pad can be either the same rock to be used in the fill or waste rock obtained from the test quarry prior to exposing that considered to be representative of the rock to be placed in the project embankment. Placement of the pad should be in at least two lifts with rolling applied until negligible settlements are observed from level readings made on its surface.

10-2. Placement of Hard to Medium Rock

In the infancy of the transition from dumped to compacted rockfill beginning in the mid-1950's, several different methods were used to dump and spread the rock. In addition, different ideas relative to the maximum rock size which should be allowed compared with lift thickness were also evident (Sherard and Cooke 1987). In the last 15 years, the considerable experience gained in construction and performance of compacted rockfill dams has resulted in general agreement on these practices for hard

to medium rock (Sherard and Cooke 1987) as discussed below.

a. The preferred method. The preferred method for rockfill placement is to dump on the surface of the layer being placed and then to spread the layer to the desired thickness with a crawler tractor by pushing the material over the advancing face of the lift as shown in Figures 10-2 and 10-3. This procedure creates significant segregation with the larger rocks in the bottom of the lift and the smaller rock and fines in the upper part. The main advantage of this technique derives from the relatively smooth upper surface resulting from pushing the dumped rock a short distance on top of each layer being placed such that depressions and voids between larger rocks become progressively filled with small rocks and fines. This approach also facilitates maintaining the desired lift thickness because the dozer operator is always advancing the lift ahead upon the smooth surface at its proper elevation. The smooth layer also reduces tire wear, allows higher truck speeds, and provides a better surface upon which to operate the vibrating roller.

b. Contrast with past practice. Earlier rockfill placement practice attempted to avoid segregation of the rock and/or generation of fines on the lift surface to form as homogeneous a compacted mass as practicable. The procedure was to dump the truck loads of rock in piles spaced upon the surface of the previously compacted lift and then to spread the piles to form the desired lift thickness. A very irregular fresh fill surface is created which makes equipment travel difficult, rapidly wears the rubber tires, and subjects vibratory rollers to damage because they do not withstand continuous operation on irregular surfaces where the drum is pounding on a few high points of hard rock. This method of rockfill placement is now considered obsolete by most specialists (Sherard and Cooke 1987), but is still occasionally proposed.

c. Stratified rockfill is preferred (Sherard and Cooke 1987). Past practitioners viewed the generation of stratified rockfill in the placement and compaction operations to yield undesirable properties with respect to permeability and compressibility. Considerable experience with the performance of rockfill dams, whether earth-core or concrete-faced, has shown that there are no technical disadvantages to the preferred method of placement in segregated layers. Sound rock derives its typically adequate shear strength from a combination of the density of the upper-lift zone of finer particles and the larger particle wedging and interlocking in the lower-lift zone rather than strictly from density. The stratification also assures that

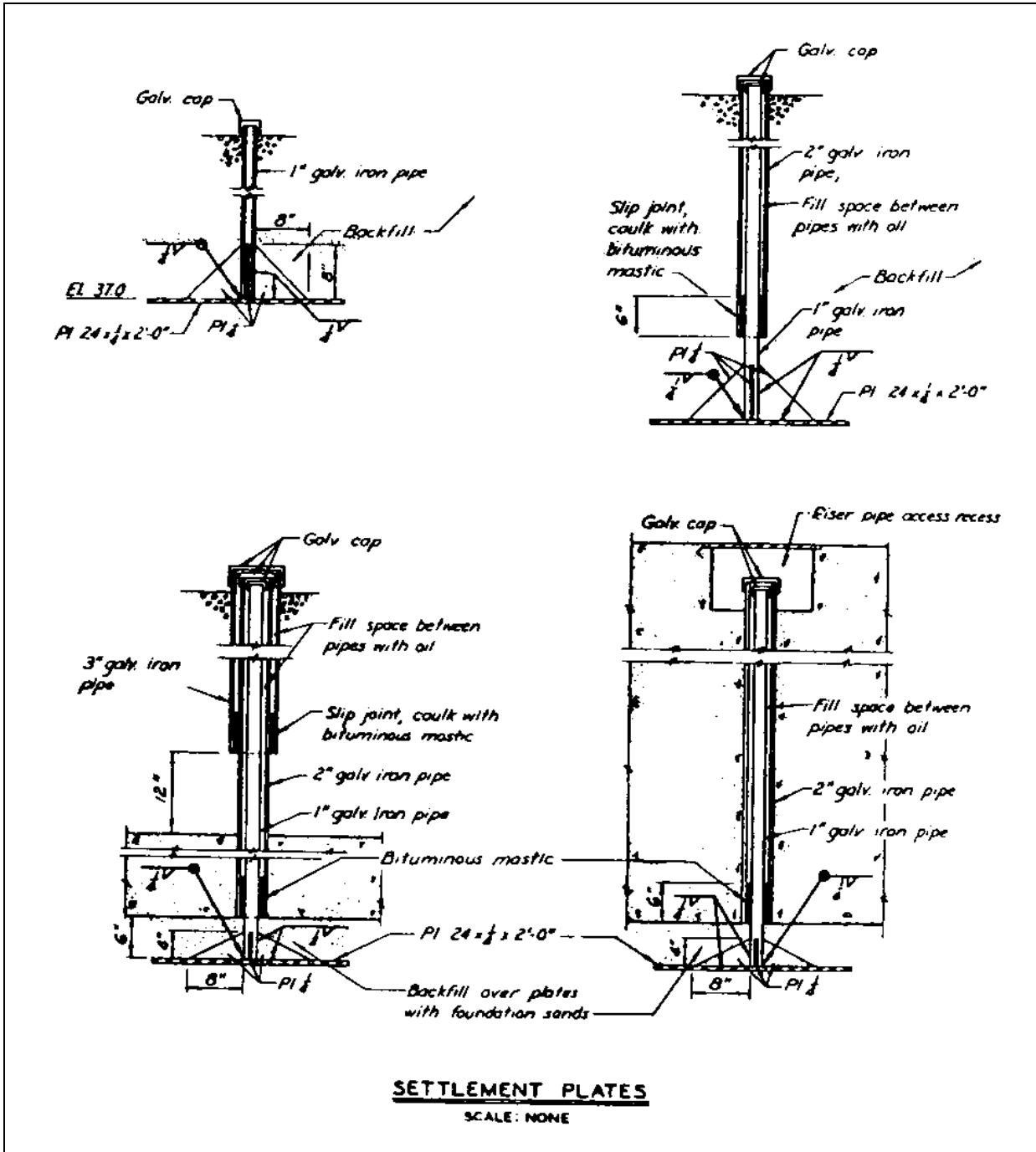

Figure 10-1. Typical settlement plates (from EM 1110-2-1908, Part 2)

any flow through the embankment will move much more easily in the horizontal direction than in the vertical which offers downstream slope stability advantages during construction for a concrete-faced dam if an upstream pool is impounded during construction or if there is an overtopping allowance during construction. Even for rockfill containing considerable fines, the stratified structure

results in a greater average permeability compared with fill placed to a more homogeneous character.

d. Lift thickness. Lift thicknesses employed in more recent times for medium to hard rock have averaged about 1 m (3.3 ft). Cooke (1990) states that the 9.1-Mg

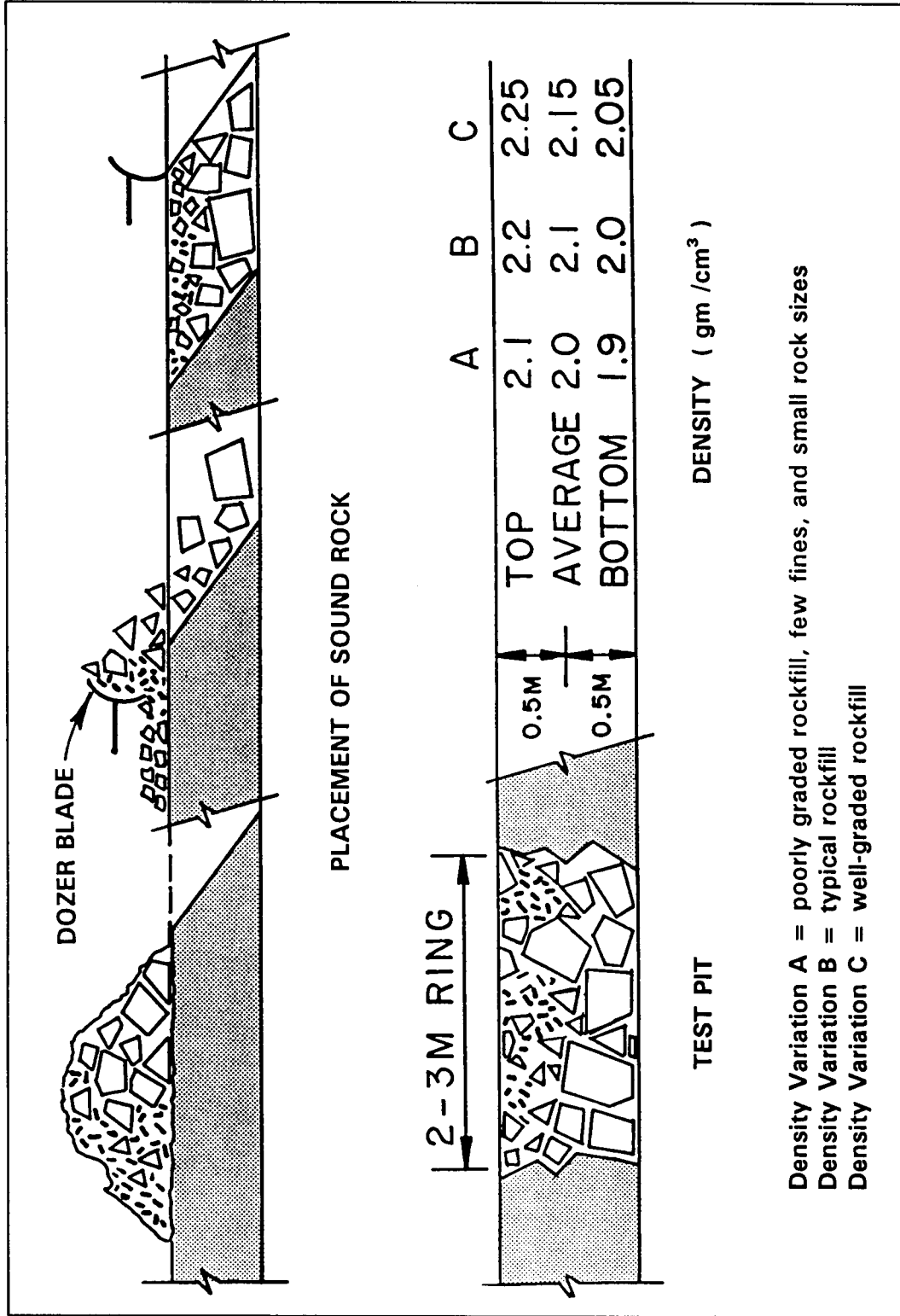

Figure 10-2. Placement of sound rockfill and resulting density variation (after Cooke 1990)



Figure 10-3. Placing a lift in the Cerrillos Dam test fill (Note the marking of the previous lift surface with plastic strips and lime)

(10-ton) vibratory roller (Figure 10-4) has generally provided excellent results for this thickness. Experience suggests that selection of lift thickness for sound rock up to about 1 m (3.3 ft.) is not a particularly critical item with respect to ability to achieve adequate compaction but can be based on quarry-run rock size brought to within the range of lift thicknesses stated above. However, the use of lift thicknesses approaching or exceeding 1 m should be on the basis of justification derived from the test fill. The literature clearly agrees that for sound rock, quarry-run material can usually be produced to be satisfactory.



Figure 10-4. A 9.1 mg (10-ton) vibratory roller at work on the Cerrillos Dam test fill

e. Maximum particle size versus lift thickness. It has been customary to limit the maximum particle size to something less than the loose-lift thickness (say, a maximum of 0.9). However, it has been clearly established that maximum particle size equal to the lift thickness is acceptable. With the preferred placement practice, the vibratory roller will seat these particles among the smaller rocks and fines. The presence of particles equal in size to the lift thickness has not been found to result in unacceptably poor compaction of intervening material, i.e., any detrimental effects on the compaction or the compressibility of the fill.

f. Grading. Sound rock is highly segregated in each lift such that grading of the quarry-run rock is not important. Cooke (1990) points out that for a given roller, well-graded quarry-run sound rock will give the highest density and modulus (lowest compressibility), but all quarry-run rock, even when poorly graded, has been satisfactory with respect to embankment performance. He further states that if the rock is hard, a satisfactory general specification is "quarry-run rock - the maximum size shall be that which can be incorporated in the layer and provides a relatively smooth surface for compaction, not more than 50 percent shall pass a 2.5-cm (1-in.) sieve, and not more than 6 percent shall be clay-sized fines." Natural gravels with sound particles do not conform to the typical definition of rockfill but may be considered for use in the shell of a dam. Loose lift thicknesses for gravels have ranged between 0.3 and 0.9 m (1 to 3 ft.) depending on particle size and percentage of minus U.S. Standard No. 200 sieve sizes (Cooke 1984).

10-3. Placement of Soft Rock

Dumped rockfill, which is still used in downstream portion of sloping-earth-core dams or in the shells of central earth-core dams, requires sound rock meeting concrete aggregate specifications. However, very low compressive strength rock such as possible in siltstones, sandstones, shists, argillite, and other potentially weak rocks may also be used as compacted rockfill. This is one of the cost advantages gained from compacted rockfill as compared with dumped rockfill in that weak rock formerly wasted from quarries for dumped rockfill dams became acceptable materials for even very high compacted embankments.

a. The preferred method. Soft (weak) rock which arrives at the test fill containing appreciable fines or which breaks down significantly in the placement

operations derives its shear strength from density so that it is generally dumped and spread by crawler tractor directly on the preceding lift to minimize segregation and yield a more compact mass. An exception would apply in cases where the breakage under the crawler tractor alters the fill from proper classification as rockfill into a soil material and alternative methods offer the possibility of retaining satisfactory rockfill traits. This statement assumes that the determination has been made that the marginal material placed in a manner retaining rockfill traits will not deteriorate into a soil material under embankment stresses or environmental factors.

b. Lift thickness. Because fill composed of soft, weaker rocks and appreciable fines derives its satisfactory properties from density, test fill results are likely to show that thinner lifts (compared with hard, durable rock) on the order of 0.46 to 0.6 m (18 in. to 2 ft) are required along with an increase in the number of passes of the roller from, say, usually 4 for hard rock to 6 or 8 for the softer, weaker rock. Some breakdown may be desirable to achieve the desired strength for these materials. The compacted mass should not exhibit any voids among larger particles, i.e., the larger particles should be consistently surrounded by finer material which has clearly been densified by the compactive effort between and among the larger particles. The use of water (to be discussed below) in the compaction of soft rock may result in the test-fill finding that somewhat thicker lifts can be used.

c. Maximum particle size. Maximum rock size may be equal to the lift thickness but these sizes will typically break down during placement and compaction.

d. Grading. Grading of weak rockfill materials is of no consequence since the procedures, i.e., lift thickness, compaction, and use of water (to be discussed below) are adopted to produce some breakdown and high density.

10-4. Rockfill Versus Soil

Weak rock introduces the possibility that it will break down during placement and compaction such that desirable shear strength and compressibility cannot be achieved unless it is compacted with water content and density control using rollers typically employed for soils. In some cases, the determination that materials will degrade to such an extent (whether by quarrying, hauling, placement, and compaction or as the result of environmental factors such as wetting or air exposure) can be made on the basis of previous experience, tests on core samples, or experience gained in the test quarry rather than resulting

from test fill observations. Otherwise, a test fill may be the only way to make the determination. It is sometimes possible to maintain the rockfill character of the material through avoidance of excessive breakage in the fill operations by processing the quarry-run material to remove fines and smaller sizes, by using rubber-tired equipment for the spreading operation, by adjusting roller passes, weight, or vibration settings, or by a combination of these. If excessive fines exist in the materials or if they are generated during compaction, the vibratory roller may be less effective in compaction compared with the 45.4-Mg (50-ton) or 68.0 Mg (75-ton) pneumatic roller. In general, materials which retain the properties to be properly called rockfill can be brought to satisfactory density using a vibratory roller. Superior compaction by a pneumatic roller would probably indicate that the material is more properly classified as a soil and should be treated as such in design, construction, and construction control. Perhaps the key concept distinguishing rockfill from that of soil is that the rock particles are in contact within the compacted mass as opposed to "floating" in a "matrix" or "binder" of soil-sized material (i.e., sands to silts or clays).

10-5. Use of Water

The use of water in compaction of rockfill (Figure 10-5) is beneficial no matter what the rock quality, but becomes especially important for types of rocks which exhibit strength loss upon wetting (usually indicated by low compressive strength) or whenever there is an appreciable presence of fines. The use of water in the compaction of weak rock, whether or not some breakdown is a desirable end, has been general practice. Indeed, one of the additional indicators as to whether or not the soft-rock material retains rockfill properties, is whether or not the rockfill is strong enough to support hauling equipment and the vibratory roller when wetted to saturation. If the equipment becomes immobile, the material ruts more than several inches under the tires of the trucks, or the added water stands upon the surface, the material has soil strength, not rockfill strength. This observational approach is valid also for hard and medium rock if excessive fines are present. The application of water has been on the order of 15 to 20 percent of the volume of the material. The use of water may represent a serious environmental factor if drainage from the fill creates turbidity pollution of the stream or river. Where water use is restricted for environmental or economic reasons, Cooke (1984) cites alternative practice of placement of weak rock in thinner lifts of 0.6 m (2 ft) or less along with an increase in the number of passes of the vibratory roller. For any weak rock which exhibits a significant loss of

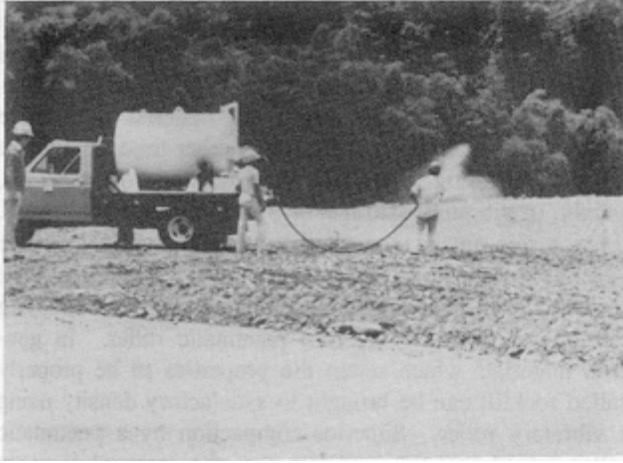

Figure 10-5. Applying water prior to lift compaction on one of the Cerrillos Dam test fills containing appreciable fines (Note: The operation shown above was an expedient method for the test fill at the Puerto Rico dams site. More typically, water is applied from a pressurized tanker truck with a rear spray bar)

strength for saturated specimens, a saturated test fill should be conducted to establish placement and compaction specifications.

10-6. Compaction and Compaction Equipment

After the rock has been placed in the desired lift thickness, the compaction operation is begun. Where surface settlement readings are to be used to assess densification (the typical practice), it is advantageous to smooth the surface of the lift for marking of the settlement grid by making one complete coverage with the vibratory roller with the vibrating unit off. The procedure for settlement readings is addressed in Chapter 11. As has been previously stated, it is important that the compaction operation be accomplished in a manner to simulate anticipated project procedures, except for interruptions required to make measurements and observations. Each pass of the roller, whether vibratory or rubber-tired pneumatic, should overlap the previous pass by about 0.3 m (1 ft). Specifics regarding the vibratory and pneumatic roller are discussed in the following paragraphs.

a. Vibratory roller. Vibratory rollers (Figure 10-4 and Appendix B) have evolved considerably since their inception in the mid-1950's. It is important for test-fill designers and field personnel to become familiar with current manufacturers' literature and recommendations for operational speed versus frequency settings to obtain the most efficient compaction. Appendix B contains recent information obtained by Los Angeles District pertaining to

these parameters and the specifications they instituted for Seven Oaks Dam. The amplitude of the roller is the distance the drum lifts off the ground in its vertical vibration and the frequency is the number of times per minute it lifts off the ground (i.e., number of impacts) expressed as vibrations per minute or VPM. Numerous studies on distance between successive impact points and centrifugal force have been conducted over the last 20 years which have resulted in the establishment of 6 to 8 impacts of the drum per lineal foot of travel as a minimum for optimal performance. Appendix B presents a table of VPM versus impacts per lineal foot for different speeds of operation of the roller. A modern roller can operate at a frequency of 1500 to 1800 VPM delivering forces in excess of 4.1 Mg (9,000 lb) per 0.3 m (1 ft.) of drum width. Increased frequency translates to increased speeds of operation which represents construction cost savings. With increased frequency, a greater force is applied and more impacts per lineal foot of rolling can take place. As part of the test fill evaluation objectives, these variables can be adjusted to provide the optimum rolling procedures for the given material and offer some latitude to alter the degree of breakdown if it is a problem.

b. Pneumatic roller. Bertram (1973) suggests specifications for a 45.4-Mg (50-ton) rubber-tired roller as follows: "Pneumatic rollers shall have a minimum of four wheels equipped with pneumatic tires. The tires shall be of such size and ply as can be maintained at tire pressures between 552 kPa and 690 kPa (80 and 100 psi) for a 11.3-Mg (25,000-lb) wheel load during rolling operations. The roller wheels shall be located abreast and shall be designed so that each wheel will carry approximately equal load in traversing uneven ground. The spacing of the wheels shall be such that the distance between the nearest edges of adjacent tires will not be greater than 50 percent of the width of a single tire at the operating pressure for a 11.3-Mg (25,000-lb) wheel load. The equipment shall be subject to the approval of the contracting officer." Pneumatic rollers should be towed or operated at speeds less than 8 kmph (5 mph). Heavier pneumatic rollers are now available and should be considered as applicable but documentation of their use on rock test fills has not been discovered. For most test fills, the optimum performance of either a pneumatic or vibratory roller has been achieved in 8 passes or less. Typically, the compaction program for any given lift thickness has been to schedule a maximum of 8 passes (lift coverages) with interruptions between each two passes for measurements and observations. After compaction of a given lift has been completed and all tests and measurements have been made, the surface of the completed lift may be covered with a marker material such as lime or a heavy

plastic membrane (0.02 cm or 8 mil maximum thickness) as shown in Figure 10-3 to facilitate identification of individual lifts within an inspection trench or pit after the

entire test fill is complete. Inspection trenches or pits will be discussed in Chapter 11.

Chapter 11 Measurements and Observations

11-1. General

Both measurements and visual observations are of importance since the overall conclusions reached from the results of a test fill program are as much qualitative as quantitative. The importance of good diary keeping and photographic records cannot be overemphasized, especially in view of the fact that design personnel who are to use the information usually cannot be present at the site at all times. Like the layout and design of test fills, the measurements and observations made are highly dependent on the primary objectives of the fill program. Advance planning and scheduling of tests are an integral part of the overall design. In this respect, flexibility is also important, since only rarely can the test program be fully laid out beforehand and carried out with no deviations. Provisions should be made for supplemental tests and for relocation, if necessary, of the test sites. Personnel who are to conduct the tests should be made familiar with the program and procedures. Personnel should also be made aware of what is expected of them as far as visual observations are concerned. It is highly desirable for a representative of the design group to be present at all times.

11-2. Densification

The densification of rockfill may be judged by: measuring the settlement resulting from compaction, performing in situ density tests, detailed observations within inspection trenches, and a combination of the preceding items. Because of the difficulty and expense of conducting enough tests to ensure representative results and because results of in situ density tests are sometimes questionable (especially for large rock), such tests should not be relied upon as the sole means of judging the effectiveness of the compaction process. Settlement determination by methods subsequently described should be used for this purpose in conjunction with visual observations in inspection trenches and with in situ density tests when available. In situ density tests are useful in that they provide quantitative values and allow comparison with the densities of other lift thicknesses or materials to be made but they are time-consuming and expensive to conduct.

a. Settlement. Settlement of the fill surface is measured by taking level readings at many points on the test section in a grid pattern. A 1.5- by 1.5-m (5- by 5-ft) square grid has often been used for this purpose. A

1.2- by 1.8-m (4- by 6-ft) or 1.5- by 2.1-m (5- by 7-ft) grid has also been used depending on the shape of the test fill area. Any grid pattern is acceptable as long as enough points are provided to obtain a good representative assessment of the overall settlement of the lift surface. There should be no less than 3 points on any one line of the grid and the edges of the grid should be no closer than 3 m (10 ft) from any outside edge of the test section to avoid settlement readings in an area where the rolling of the fill may have caused bulging. The areas to be avoided for settlement readings also include those next to the access ramps where lateral movement may also occur against the random, more compressible material often placed in those areas. Examples of settlement grid layouts are shown in Figure 11-1.

(1) Prior to establishing the grid points on the uncompacted lift surface, a leveling pass should be made by the vibratory roller with the vibratory unit off. This will provide a smoother surface upon which to establish and mark the grid points and to confirm the loose-lift thickness. This leveling pass with the vibratory roller can also be used when other types of rollers are to be assessed.

(2) There are several methods to establishing the grid. In most cases, wires or strings have been pulled from perimeter stakes set at the desired spacing. Another satisfactory method has utilized a light-weight template consisting of a metal frame strung with wire or twine. In any event, after the points are located, they should be well marked on the fill surface with contrasting paint to facilitate identification for subsequent level readings.

(3) Since the reading at a point must represent the area surrounding it (for points on 1.5-m (5-ft) centers, for instance, each point represents a 1.5- by 1.5-m (5- by 5-ft) area), it is important that the level rod be placed where it is indeed representative of this area and not influenced by local irregularities at the point. This is an expectable problem on a rockfill surface which can be ameliorated by use of the device shown in Figure 11-2. The simple device consists of a 0.3-m (1-ft) square metal plate with a raised button in its center upon which the level rod is seated for readings. A handle made from a steel rod is attached to the plate to help in firmly seating it and transporting it from point to point. The leveling instrument should be located carefully with regard to equipment trafficking so as to avoid its disturbance throughout placement and rolling operations. Bench marks should be established in secure places well away from the fill area. These are well known good survey

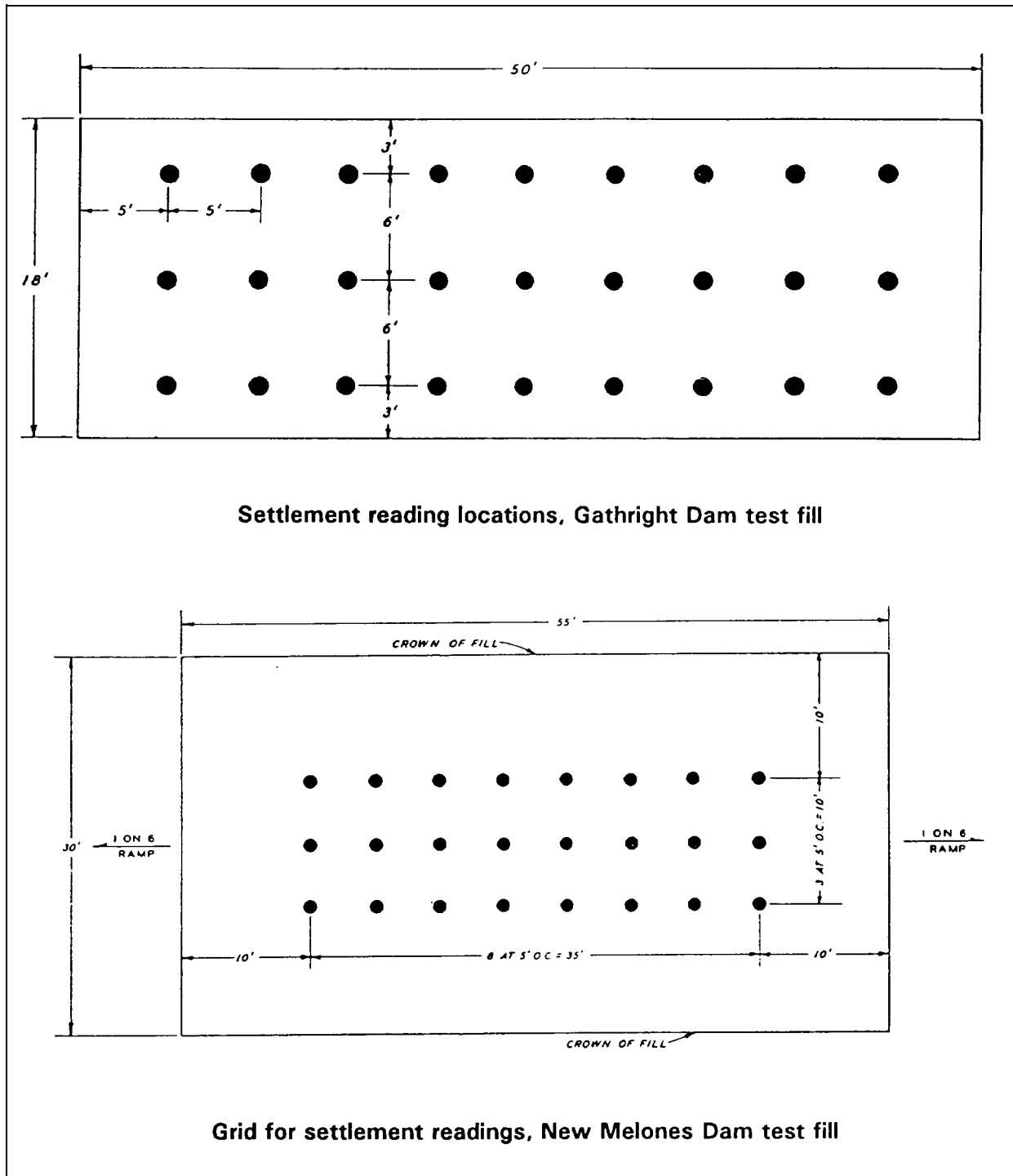

Figure 11-1. Example settlement grid layouts

practices but reports on past test fills have attributed erratic settlement results to disturbance of the level instrument in more than a few cases.

(4) The settlement of a particular lift is obtained by averaging the settlements measured at all points in the grid usually expressing it as a percentage of loose-lift



Figure 11-2. Apparatus for taking level readings

thickness. If a number of passes of the roller is a variable being evaluated, readings of the grid points are usually made after every two passes or coverages of the roller. One pass of a pneumatic or vibratory roller is equivalent to one coverage. Those points that indicate heave rather than settlement may be eliminated from the averaging process if none of the surrounding points indicate heave or if it is noted (by careful observation and documentation by the rodman) that a local condition at the point is not representative of the surrounding area. If settlement plates have been installed beneath the fill on a compressible foundation, they should be read at the same frequency as the surface grid points, and any settlement they indicate averaged and subtracted from the lift surface settlement.

b. In situ density tests. The typical means of performing an in situ density test in rockfill is by excavating a test pit in the fill, salvaging and weighing the removed material, and determining the volume of the pit by the water-volume method. The volume of material excavated is necessarily large in order to minimize the effects of the larger particles on the results. The test pit may be either square or round in plan shape and a rigid template of wood or metal is anchored on the fill surface as a guide in excavating the hole. The template size and, therefore, the volume of the test pit varies on the basis of the maximum particle size in the compacted material. The most popular template seen in the rockfill literature has been round and metal. For that reason, in situ density tests in rockfill are often referred to as "ring densities." Since rockfill is segregated or stratified, the test pit should be excavated through the entire lift to obtain an average density. The use of lift marker material such as lime or

plastic sheeting previously mentioned in paragraph 10-5 proves its worth in clearly indicating the lower lift boundary. Detailed guidance in conducting the test is now provided as ASTM Designation D 5030 - 89 (see ASTM 1994a). Weighing of the total sample removed from the density test typically requires high-capacity scales and may even involve weighing of individual larger particles. Rockfill materials are typically not placed under density and/or water-content specifications as are soils but are placed under method-type specifications with no water content control. The in situ density test is not used as a construction control test in project construction simply because of its time-consuming nature, the fact that rockfill density numbers have little specific meaning in design and the method-type specification coupled with good observation is relied upon for compaction quality. This is precisely why a test fill is so important, i.e., to aid in developing the proper method specification. The value of the test is primarily as a basis of comparison of compaction procedures in a test fill in establishing the method specification, i.e., lift thickness and number of passes by a specified roller, and to obtain as-built data during construction. Because of the heterogeneity of rockfill, in situ tests taken in the same lift at different locations can be expected to yield different results although more than one test per lift is rarely ever performed to reveal that expectable occurrence. In some cases, in situ tests have been employed in project construction, not only to obtain as-built data, but also when changes in materials or compaction results are suspected. U.S. Committee on Large Dams (1988) presents the experiences of several agencies, including the Corps of Engineers, with respect to in situ density testing.

c. Laboratory maximum density test. It has not been uncommon practice to compare the results of in situ density tests with the results of some version of vibrated laboratory maximum density. Both the Corps of Engineers (EM 1110-2-1906) and ASTM Designation D 4253-93 (ASTM 1994c) provide standard procedures for cohesionless materials with a maximum particle size of 7.6 cm (3 in.). EM 1110-2-1906 allows the scalping of up to 10 percent by weight of particles larger than 7.6 cm (3 in.) but ASTM requires that 100 percent of the material is smaller than 7.6 cm (3 in.). The literature such as U.S. Committee on Large Dams (1988) describe various non-standard large scale vibrated tests in large molds. The U.S. Army Engineer District, Los Angeles (1992) performed saturated tests in a 68.5-cm (27-in.) diameter mold on minus 15.2-cm (6-in.) scalped fractions of Seven Oaks Dam test fill gradations. The U.S. Army Engineer Waterways Experiment Station conducted an unpublished and limited test program on minus 15.2-cm (6-in.) rock

employing standard tests in the 27.9-cm (11-in.) diameter mold on minus 7.6-cm (3-in.) scalped fractions and full-scale gradation tests in a 1.83-m (6-ft) diameter mold vibrated with an MTS® system actuator. That test series showed that the results of the standard test could be corrected for the oversize (plus 7.6-cm (3-in.) fraction) using the following equation of EM 1110-2-1911, Appendix B (Ziegler 1948):

$$\gamma_f = \frac{f\gamma_t\gamma_w G_m}{\gamma_w G_m - c\gamma_t} \quad (11-1)$$

or, solving for γ_t :

$$\gamma_t = \frac{\gamma_f\gamma_w G_m}{f\gamma_w G_m + c\gamma_f} \quad (11-2)$$

where, for this particular case:

γ_f = maximum dry density of the minus 7.6-cm (3-in.) fraction obtained from the standard EM 1110-2-1906, Appendix XII, vibratory table test, metric ton/m³ or lb/ft³

f = percentage by weight of the total sample represented by the finer fraction, i.e., the minus 7.6-cm (3-in.) fraction

γ_t = calculated maximum dry density of the total material, metric ton/m³ or lb/ft³

γ_w = unit weight of water, 1 metric ton/m³ or 62.4 lb/ft³

G_m = bulk specific gravity of the oversized fraction (plus 7.6-cm or plus 3-in.), see EM 1110-2-1906, Appendix IV

c = percentage by weight of the total material represented by the coarser fraction, i.e., the plus 7.6-cm (3-in.) fraction

11-3. Gradation Tests

Gradation tests are used to determine the amount of breakage the rock has suffered during placement and compaction. This is accomplished by running gradation tests on samples representative of the material as

delivered to the fill (“before” gradations) and on samples taken from the compacted fill (“after” gradations). Differences in the two resulting curves indicate the degree of breakdown of the material. After-compaction samples are usually obtained from material excavated from the fill density test pit or from the side walls of inspection trenches or test pits. Again, it is important that the entire thickness of a lift be sampled. At the present time there is no standard procedure for obtaining the gradation of rockfill materials. A gradation sample must also be large in order to obtain a representative gradation curve with reasonable accuracy in the results. One approach to the concept of accuracy is to consider a test sample of such size that the addition or loss of the largest particle will not alter the “percent finer by weight” by more than an acceptable number of percentage points (i.e., shift the gradation curve coarser or finer). For instance, for a test sample to approach 1 percent accuracy, assume that the largest particle weighs 68 kg (150 lb). For this rock to correspond to less than 1 percent of the total sample weight, the total gradation sample size would have to be 6.8 metric tons (15,000 lb). In a similar manner, for 2 percent accuracy, the sample would have to weigh 3.4 metric tons (7,500 lb). From a practical point of view, a 1 percent accuracy is probably an extreme requirement and a 2 percent accuracy is a reasonable minimum criteria. The difficulty for rock materials lies in handling the heavy sample, obtaining its total weight, dividing it into fractions for gradation by different procedures, and then mathematically recombining the results on the fractions into a single gradation curve. A large, clean area (preferably a concrete slab) is needed to spread out the larger particle fraction. Determining the percentage by weight of total sample which the largest particles in various size ranges represent typically requires hand measurement in some manner of the size of larger particles and the summing of their weights for selected size ranges. Procedures for rocks larger than 12.7 cm (5 in.) now provided in ASTM Designation: D 5519-93 (ASTM 1994d) may be considered applicable for rock fill materials though specifically they are directed at riprap. For the total material fraction smaller than that treated by ASTM Designation: D 5519-93 (ASTM 1994d), gradation test procedures for aggregates such as Designation: C 136 (ASTM 1994b) and for soils such as Designation: D 422 (ASTM 1994c) or EM 1110-2-1906, Appendix V are available. The U.S. Committee on Large Dams (1988) describes the past large-scale gradation practices of several agencies which may also still be considered applicable. The procedures used in the construction of

Carter's, Cerrillos, and Seven Oaks Dams were described previously in paragraph 6-5.

11-4. Percolation Tests

Rockfill in a dam shell is assumed to be a free-draining material in design. In cases where the material breaks down such that it exhibits poor to practically impervious drainage characteristics, the zoning of the embankment should ordinarily specifically provide for the use of such materials. It may be one of the objectives of the test fill to determine if such embankment design features must be incorporated to efficiently use available materials. For hard to medium rock, there is rarely a need to perform percolation (infiltration) tests to verify the free-draining characteristics. Assessments of the drainage characteristics of rockfill are very crude and are properly termed "percolation" or "infiltration" tests as opposed to "permeability" tests. Field methods applied in the test fill can only yield a very rough estimate of permeability because, among other factors, the material is unsaturated and the area of flow discharge is not known. Furthermore, the variability of the rockfill itself and that of permeability determinations (even under the best of laboratory conditions) would likely result in different values at different locations in the same lift of orders of magnitude. It has become customary to describe soil-rock materials with permeabilities less than 0.3 m/year (1 ft/year) as impervious, those with permeabilities between 0.3 and 30 m/year (1 and 100 ft/year) as semipervious, and those with permeabilities greater than 30 m/year (100 ft/year) as pervious (U.S. Department of the Interior, Bureau of Reclamation 1985). These ranges were derived from Terzaghi and Peck (1948) who described them as representing good drainage characteristics if permeability is greater than 10^{-4} cm/sec (103 ft/year), poor drainage characteristics if permeability is between 1×10^{-6} cm/sec and 1×10^{-4} cm/sec (1 and 103 ft/year), and practically impervious if permeability is less than 1×10^{-6} cm/sec (1 ft/year). The following paragraphs describe several versions of a percolation test given in the order of decreasing applicability for most test fill situations.

a. Open pit method. This method has been by far the most commonly used. Percolation tests are usually performed in either the in situ density test hole after removal of the plastic liner employed to obtain the water-volume or in a separate pit at least 1-m (3-ft) square and at least one lift thickness deep. If the pit will not retain a sufficient volume of water to measure the rate of fall of the water surface, the compacted material is obviously free-draining. If the pit can be filled such that a rate of fall of the water surface can be measured, the percolation

rate (the distance the ponded water surface falls in the pit over a measured time) in centimeters/second, meters/day or ft/day may be taken directly as a very rough indication of the permeability. This simple approach will overestimate the permeability and further guidance concerning its use given in paragraph 11-4c below should be considered. However, if this crude method indicates that the drainage characteristics are less than free-draining, it is a reliable assumption that they are. Justo (1991) provides a more theoretical method to estimate a permeability from the rate at which the water surface in a test pit falls, i.e., a falling-head test. The permeability is calculated with reference to Figure 11-3 and using the following equation. An example calculation is given below in paragraph 11-4c.

$$k = - \frac{\Delta h}{\Delta t (1 - n \Delta S)} - \frac{h_0 n \Delta S}{\Delta t (1 - n \Delta S)^2} \quad (11-3)$$

$$\ln \frac{h n \Delta S - \Delta h}{h_0 n \Delta S}$$

where, for any consistent set of units:

k = coefficient of permeability

h_0 = the initial depth of water in the pit at time $t = 0$ sec

h = depth of water in the pit after a time Δt sec

$\Delta h = h_0 - h$ = change in depth of water in the pit during time interval Δt sec. **Δh takes a negative sign in the above equation because in its derivation, as the head decreases during the test, the volume of water in the material from the bottom of the pit to the wetting front is increasing.**

n = the porosity of the fill beneath the pit, dimensionless

ΔS = change in degree of saturation (expressed as a decimal value) of the material below the pit from its initial value before filling of the pit to its wetted value during the test.

This approach assumes that the pit is filled instantaneously which is not the practical case and the change in degree of saturation must be estimated. Furthermore, flow is assumed to take place only in the vertical

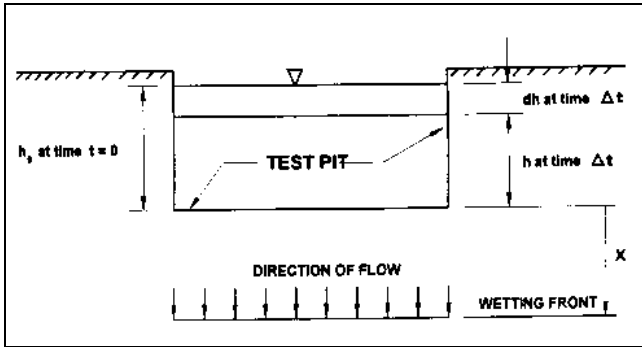

Figure 11-3. Open-pit percolation test after Justo (1991)

direction such that at any distance x below the pit (see Figure 11-3), the area of discharge is not assumed to have increased. This assumption represents a severe simplification of the flow pattern since flow will occur through the side walls of the pit below the water level and will also spread out laterally beneath the pit with distance x in downward movement of the wetting front. Since increase in discharge area with distance below the pit is not considered, the calculated value of permeability will be larger than the actual value to some unknown degree assuming that all other parameters entered into the equation are correct. The initial degree of saturation of the fill and its porosity can be calculated according to EM 1110-2-1906, Appendix II, from a knowledge of the initial water content of the fill, the specific gravity of the material, and the compacted density of the fill. This information can be obtained as part of the conduct of a fill-density test. If the fill contains more than about 10 percent by weight of particles passing the U.S. Standard No. 4 sieve, the specific gravity of the material should be calculated using the equation given in EM 1110-2-1906, Appendix IV, paragraph 3e, for materials consisting of both plus and minus No. 4 sieve fractions. The wetted degree of saturation of the fill beneath the test pit at the time Δt during conduct of the percolation test must be estimated. The wetted degree of saturation may vary between about 75 and 95 percent. A reasonable value to assume for the computation of permeability is 85 to 90 percent.

b. Standpipe methods. The standpipe methods to be described below consist of using a cased hole (i.e., an implanted metal or plastic pipe in the case of the rock test fill) to perform either a constant-head or falling-head permeability test. The falling-head standpipe test is probably the most technically sound method among the four methods presented because it does consider the increase in area of flow (to be discussed below) after a fashion proven in model studies. The standpipe tests are applicable in materials exhibiting many times the permeability

identified previously as indicating good drainage characteristics. However, they should not be used unless the fill contains appreciable fines and the considerable time and costs are deemed to be justified. The fill should probably exhibit a minus No. 4 sieve fraction exceeding 30 percent by weight or a minus No. 200 sieve fraction of 10 percent or more by weight in order that it not be so permeable as to outstrip the practicality of a standpipe test. If the material is gap-graded, the question of its permeability outstripping the practicality of the standpipe test is complex but if the finer fraction does not fill the voids between the larger particles, the permeability is likely to be very high. There are no firm guidelines concerning the diameter of the pipe but ideally it should not be less than twice the diameter of the maximum particle size of the material after compaction. If this criterion dictates a very large (in practical terms) pipe diameter, say, exceeding about 61 cm (2 ft), a ratio of diameter to maximum particle size of less than two may be used but with care taken to avoid a single particle immediately below the tip of the pipe which would constrict flow. The objective is to test the mass of the compacted rock to the maximum practical extent. The pipe should be inserted into the fill to a sufficient depth such that it is stable in position. In general, the pipe must be placed in an excavation kept to minimal working dimensions and then backfilled about its exterior with the excavated material with some attempt to maintain its approximate gradation as it was in situ. Material above the level of the tip of the pipe has some impact on results because the flow of water has been shown by model tests to develop a wetting front in the unsaturated material which is approximately spherical about the tip of the pipe.

(1) Schmid (1967) provides a method for estimating permeability from the results of a falling-head test performed above the ground water table (in unsaturated material) in a standpipe. Because the volume of the standpipe is small compared to the ability of the material to consume the flow, the depth of pipe embedment need only be that sufficient to stabilize it. Figure 11-4 shows the configuration of the test and the spherical wetting front (documented by model tests) which develops as the water flows from the pipe. The equation Schmid (1967) derived is given below. An example calculation is given in paragraph 11-4c.

$$k = \frac{r_0}{4} \frac{\ln \frac{h_1}{h_2}}{t_2 \left[\frac{3(h_1 - h_2)}{4 n \Delta S r_0} + 1 \right]^{\frac{1}{3}} - t_1} \quad (11-4)$$

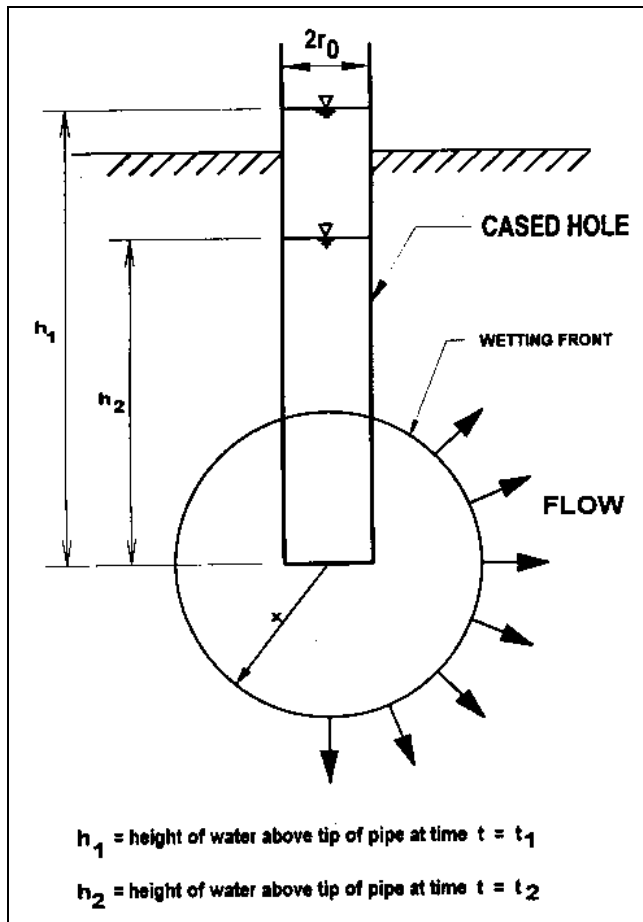

Figure 11-4. Falling-head standpipe percolation test after Schmid (1967)

where for any consistent set of units:

k = coefficient of permeability

r_0 = inside radius of the standpipe

h_1 = height of the water above the tip of the standpipe at time $t = t_1$

h_2 = height of the water above the tip of the standpipe at time $t = t_2$

ΔS = change in degree of saturation of the rockfill from its initial value to its wetted value expressed as a decimal value.

n = the porosity of the rockfill

The wetted degree of saturation can again be assumed to be 85 to 90 percent as previously stated in paragraph 11-4a.

(2) The U.S. Bureau of Reclamation in its *Earth Manual* (USBR 1985) provides an open-end field permeability measurement method as Designation E-18. The method consists of measuring the flow rate of water required to maintain a constant head in the pipe under a constant rate of flow. Gravity flow in an open standpipe or pressurized (pumped) flow in a sealed standpipe may be used. For this test, the pipe must be inserted into the fill to a depth such that the head of water applied as measured from the tip of the pipe is less than the depth of embedment. Otherwise, the flowing water may rise about the pipe to exit upon the surface of the fill which will invalidate the already approximate test method. This constant-head test is complicated for use in rock test fills by the need to measure and maintain the flow rate, and by the necessity to maintain either a relatively constant water level in the pipe (gravity flow) or a relatively constant pressure (pressurized flow). In tests using gravity flow, a constant water level in the standpipe is rarely maintained in unsaturated materials and a surging of the level within less than 15 cm (6 in.) at a constant rate of flow for about 5 minutes is considered satisfactory. In the pressurized test, this acceptable head variation corresponds to a pressure variation of only about 21 kPa (3 psi). The equation used to calculate permeability was derived by the USBR from electrical analogy studies and is given below (see Figure 11-5). An example calculation is given in paragraph 11-4c.

$$k = \frac{Q_d}{5.5 r_0 H_w} \quad (11-5)$$

where, for any consistent set of units:

k = coefficient of permeability

Q_d = flow rate

H_w = applied head

r_0 = inside radius of the standpipe

c. *A comparison of the methods.* Justo (1991) compares results of open-pit and standpipe percolation

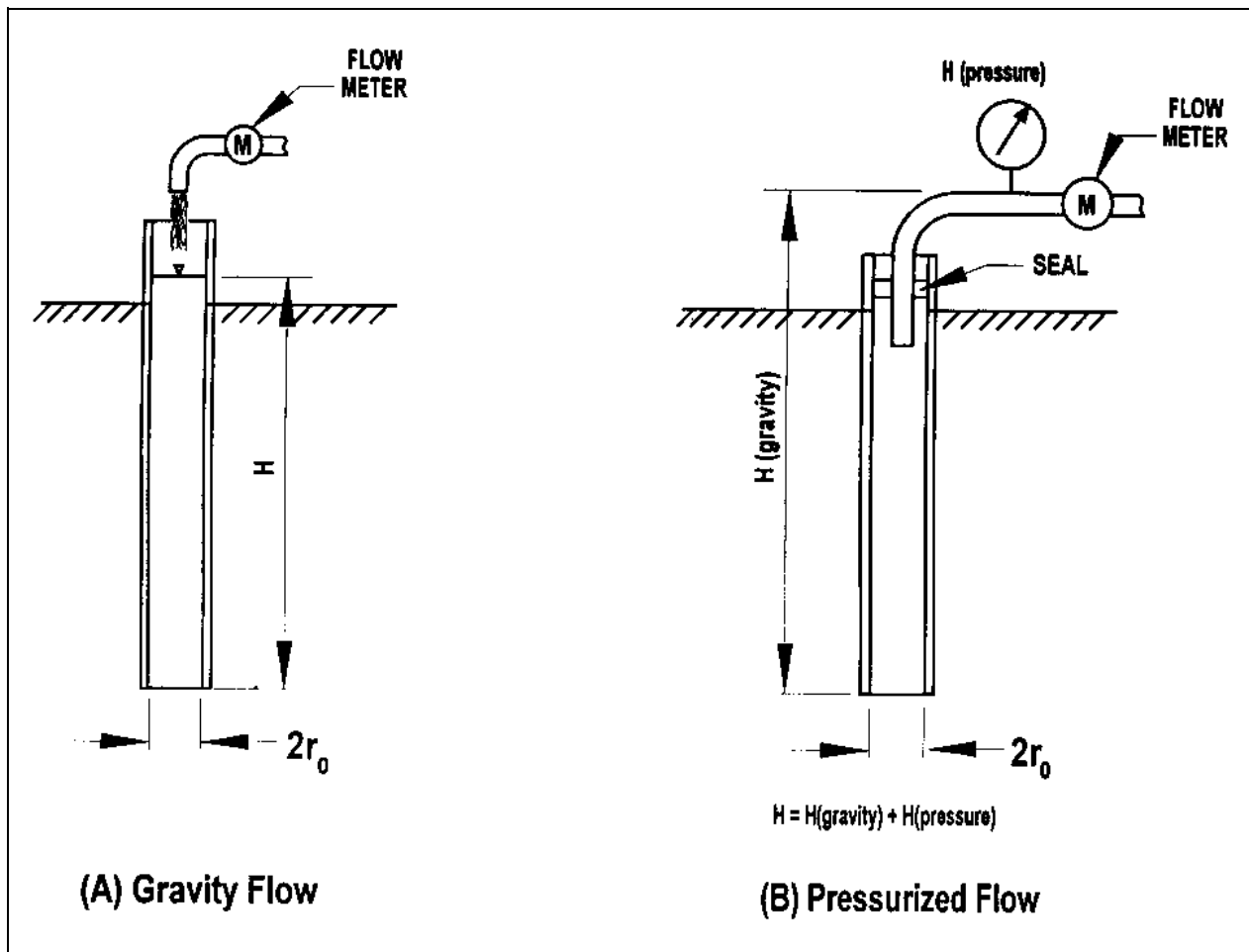

Figure 11-5. USBR gravity flow and pressurized flow standpipe percolation tests

tests performed in the test fill for Martin Gonzalo Dam, Cordoba, Spain. The open-pit method was conducted in a pit excavated to dimensions of 1m square by 0.25 m deep (3.3-ft square by 9.8 in. deep). Both the USBR constant-head, constant-flow test and the falling-head test were performed in standpipes. The permeabilities according to the equations (11-3) through (11-5) presented above in paragraphs 11-4a and 11-4b are calculated below.

(1) The open pit was filled to an initial depth of 25 cm (9.8 in.), i.e., to the surface of the test fill. Parameters pertinent for entry into Equation (11-3) of paragraph 11-4a were as follows:

$$\text{dry density of the fill} = 2.14 \text{ Mg/m}^3$$

$$\text{porosity of the fill} = n = 0.20$$

$$\text{initial degree of saturation } S_i = 10 \text{ percent} = 0.10$$

$$\text{wetted degree of saturation } S_w = 90 \text{ percent} = 0.90$$

$$\Delta S = (S_w - S_i) = (0.90 - 0.10) = 0.80$$

$$1 - n\Delta S = 1.0 - (0.20)(0.80) = 0.84$$

$$h_0 = 25 \text{ cm}$$

Δh during conduct of the test was 11 cm (-4.33 in.) over a time period $\Delta t = 180$ sec. It is important to apply a minus sign to Δh in the equation (11-3). Because Δh observed was 11 cm (4.33 in.), h at time $\Delta t = 180$ sec = $h_0 - \Delta h = 25 \text{ cm} - 11 \text{ cm} = 14 \text{ cm}$ (5.51 in.)

Substituting into Equation (11-3):

$$k = - \frac{-11}{180 \times 0.84} - \frac{25 \times 0.16}{180 \times (0.84)^2} \quad (11-6)$$

$$\ln \frac{(14 \times 0.16) - (-11)}{25 \times 0.16}$$

or:

$$k = 0.0728 - 0.0377 = 0.0351$$

$$= 3.51 \times 10^{-2} \text{ cm/sec} = 1.1 \times 10^4 \text{ m/yr}$$

The material is free-draining according to the criteria discussed in the first part of this section because the measured permeability is a great deal in excess of 30 m/year (103 ft/yr).

(2) The parameters from the Martin Gonzalo Dam tests pertinent for substitution into Schmid's Equation (11-4) of paragraph 11-4b(1) were as follows:

As before

$$n\Delta S = 0.16$$

radius of the standpipe $r_0 = 10.25$ cm

$$h_1 = 40 \text{ cm}$$

$$h_2 = 20 \text{ cm}$$

$$t_1 = 0$$

$$t_2 = 192 \text{ sec}$$

substituting into Equation (11-4):

$$k = \frac{10.25}{4} \frac{\ln 2}{192 \left[\frac{3 \times 20}{4 \times 0.16 \times 20.5} \right]^{1/3}} \quad (11-7)$$

$$k = 5.2 \times 10^{-3} \text{ cm/sec} = 1.64 \times 10^3 \text{ m/yr}$$

(3) With respect to the USBR standpipe method, the constant flow measured for a constant head of 30 cm was 34.38 cm³/sec in the same standpipe with $r_0 = 10.25$ cm. Substituting into equation (11-5) yields:

$$[k = \frac{34.38}{5.5 \times 10.25 \times 30} = 2.03 \times 10^{-2} \text{ cm/sec}$$

$$= 6.40 \times 10^3 \text{ m/yr}$$

The values of permeability yielded by the three tests given above vary by about one order of magnitude (one power of 10) which is an excellent result considering the differences in the tests and the partially saturated state of the fill. The permeability of a partially saturated soil is very sensitive to the pore space filled with water or the so-called "effective porosity." Even permeability tests performed on replicate specimens (specimens carefully prepared to be as identical as practicable) of a saturated soil in a laboratory environment using different methods of test and calculation of coefficient of permeability may yield results of greater variation than seen in the above examples. It is instructive to note from the open-pit test above that if the permeability is estimated by simply the fall of the water $\Delta h = 11$ cm divided by the time lapse $\Delta t = 180$ sec, i.e.:

$$k = \frac{11}{180} = 6.11 \times 10^{-2} \text{ cm/sec} \quad (11-8)$$

$$= 1.93 \times 10^4 \text{ m/yr}$$

the resulting number is on the order of 2 times the value yielded by the Justo open-pit method to 10 times the value obtained from the Schmid falling-head standpipe method. Since the Justo method overestimates the permeability for reasons previously stated, it is recommended that the permeability estimated directly by fall of the water Δh divided by the time lapse Δt be reduced by a factor of 10 in judging the actual drainage characteristics of the fill.

11-5. Other Tests

It is beyond the scope of this manual to provide a treatise on the subject of rock testing. Most current laboratory tests do not have direct correlative relationships to rockfill with respect to either rock quality specifically as a fill material or its engineering properties or behavior. For high-quality, hard to medium rockfill materials, laboratory shear tests, compressibility tests, and associated stability analyses are typically not performed for the embankment itself and embankment slopes are adopted at 1 vertical on 3 horizontal since the shear strength of sound rockfill is

well established to be at least $\phi = 45$ degrees. The designer must make a decision regarding rockfill which breaks down significantly as to whether it still retains rockfill strength or must be treated as a soil containing large particles, in which case embankment stability analyses may be required. Of course, in the event that there exists the possibility that embankment failure may involve the foundation, stability analyses are conducted for those cases regardless of the quality of the rockfill. The comments provided below are very general and divided into the categories of laboratory tests and field tests.

a. Laboratory tests. There are a number of index-type tests which may be performed on rock to obtain a judgment of its mechanical or environmental durability. In addition to the tests previously mentioned in Part 1 of this manual (some are ASTM Standards), there is the Los Angeles Abrasion test for large aggregate described in ASTM Designation C 535-89 (ASTM 1994b). That test is restricted to minus 7.6-cm (3-in.) particle sizes and has limited usefulness in indicating the likely breakdown of material under placement and compaction operations. Hammer and Torrey (1973) attempted to analyze available data from test fills to correlate Los Angeles Abrasion data to degradation during handling and compaction. Their attempts were not successful at that time and no subsequent correlations are known to exist based on the improved procedures of ASTM C 535-89. At least it is reasonable to assume that rock which suffers serious degradation in the test will suffer significant breakdown in rockfill operations. EM 1110-2-2302 lists several tests and criterion for suitability of stone for general construction use (see Table 11-1). Those criterion are very general and should be considered to indicate the higher quality rockfill materials which may be relatively obvious without test results in many cases and, therefore, do not help much in prediction of rockfill qualities of softer materials. Other references pertinent to rock and rockfill quality testing are Lutton, Houston, and Warriner (1981), U.S. Army Engineer Waterways Experiment Station (1993), and NATO ASI Series (1991). Donaghe and Torrey (1985) and Torrey and Donaghe (1991) treat the shear strength and compaction characteristics of earth-rock mixtures (soil materials). Lutton (1977) and Strohm, Bragg, and Ziegler (1978) address shale materials which may appear as rockfill upon excavation and placement but which degrade with wetting into a soil.

b. Other field tests. In situ tests (other than in situ density and percolation tests) may be performed in the test fill to assess the strength and compressibility of the compacted material although such tests have very rarely been used in this country. As described by Justo (1991),

compressibility has been assessed by large plate load tests and shear strength has been measured by plate load tests taken to failure and in situ passive failure shear tests (jacking a vertical plate against a vertical rockfill face).

11-6. Visual Observation

Because of the nature of a test fill, visual observation of the various construction procedures and material behavior are very important as a source of qualitative supplemental information. Some items meriting close observance are: preparation of the leveling pad before fill construction, installation procedures for any instrumentation such as settlement plates, character of the rock delivered to the fill such as consistency in gradation and condition, breakage of the rock during spreading relative to the degree of working by the crawler tractor, breakage of the rock during compaction, effects of added water (if any), smoothness of the surface after each interval of rolling, appearance of the fill during and after rainfall, and any variation in established behavior of any phase of the construction operation. All visual observations should be well documented with photographic evidence and a written record.

11-7. Inspection Trenches or Pits

It is highly desirable to expose a cross section of each test section or lane in order that general in situ characteristics of the compacted fill might be observed. This is achieved by the excavation of pits or inspection trenches. The inspection pit is excavated from the top down through a lift immediately after rolling or through all or part of the lifts after the entire test section or lane is completed. An in situ density test excavation can also serve as an inspection pit. If separate inspection pits are employed through several lifts, they should be large enough in plan area to permit the safe presence of personnel to inspect the side walls and even take samples. An inspection trench is a cut made through the entire depth and usually across the entire width of the completed test section or test fill. Excavation is normally with a front-end loader or dozer. The inspection trench is most often used, since the only advantage of an inspection pit is that it can be dug at any stage during the rolling operation, but this is not often justified. Except as a source of after-compaction gradation samples, an inspection trench is primarily for qualitative examination such as amount of rock-to-rock contact of the compacted material. Figure 11-6 shows such an inspection trench cut through the test fill for New Melones Dam. That trench was excavated approximately along the line of cross section A-A of Figure 9-5. Note

Table 11-1
Criteria for Evaluating Stone (after EM 1110-2-2302)

Test	Approximate Criterion for Suitability*
Petrography	Fresh, interlocking crystalline, with few vugs, no clay minerals, and no soluble minerals
Unit Weight	Dry unit weight 160 lb/cu ft or greater
Absorption	Less than 1 percent
Sulfate Soundness	Less than 5 percent loss
Glycol Soundness	No deterioration except minor crumbs from surface
Abrasion	Less than 20 percent loss for 500 revolutions
Freezing-Thawing	Less than 10 percent loss for 12 cycles
Wetting-Drying	No major progressive cracking
Field Visual	Distinctions based on color, massiveness, and other visual characteristics
Field Index	Distinctions based on scratch, ring, and other physical characteristics
Drop Test	No breakage or cracking
Set Aside	No breakage or cracking after one season cycle

* Marginal test results usually indicate the need for supplemental testing for definitive evaluation

from Figure 11-6 that the trench is of such a width compared with the maximum height of fill as to ensure the safety of personnel moving about within it to observe the side walls or take samples. Regardless of the size of inspection pits or trenches, personnel entering them should be screened for the proper and usually required construction safety equipment such as steel-toed footwear, hard hats, and safety eye wear in the event that a heavy particle or shower of smaller material unexpectedly falls. This is particularly important since the side walls are typically loose and covered with some fall-out material requiring hand work (accomplished as excavation proceeds) to obtain a view of representative in situ material. If after-compaction gradation samples are to be taken from the side walls, the non-representative fall-out material must be excluded from the sample. The use of lift-surface markers such as lime or plastic sheeting (as previously discussed) are important to permit the pit or trench inspectors to clearly distinguish one lift from another. Items of interest when inspecting a pit or trench include: depth of fines on the lift surfaces, distribution of fines within the lift, the overall appearance of each lift such as the segregation pattern, occurrence of voids, and the



Figure 11-6. Inspection trench through the New Melones Dam test fill

general “tightness” of the fill, including the stability of the side walls. Thorough documentation of the inspection trench is very important including photographs and a written record. It should be considered imperative that design personnel take part in the inspections.

Chapter 12 Evaluation of Test Fill Results

12-1. General

It has been shown in the previous portions of this manual that information accumulated from a test fill program consists of both qualitative and quantitative data. In analyzing that data and drawing conclusions for design purposes, it is necessary to consider all the data in that qualitative data should not be neglected or ignored even in the presence of strong quantitative data. This is true because quantitative data previously addressed is subject to considerable variation with location in a rockfill, may not be completely representative, or may have been obtained by methods which are not standardized. The remainder of this chapter will be directed at describing the typical usages of gathered data in assessing the placement and compaction procedures.

12-2. Settlement Data

Settlement data have generally been the most useful information for determining the best combination of loose-lift thickness, number of passes, roller type (compaction effort), and material gradation. Settlement data are normally plotted with settlement as the ordinate (y-axis) and actual loose-lift thickness as the abscissa (x-axis) and for each two passes of the roller. Of course, settlement can also be plotted against any of the other listed variables. The type plot used will be dependent upon the variable to be evaluated, but the data should always be plotted in several ways since some relationships will be more apparent in one form of plot compared with others. The settlement readings may be expressed as the actual values in cm or inches or as a percentage of the loose-lift thickness. If, as usual, settlement is to be compared for different loose-lift thickness, it is preferable to express it as a percentage of the loose-lift thickness because that number represents a relative densification. Figures 12-1 through 12-4 show example plots of percent settlement versus roller passes. Figure 12-5 through 12-7 show example plots of percent settlement versus loose-lift thickness.

12-3. Roller Passes

In evaluating the number of roller passes, economics must be considered in that a true optimum based on performance alone can rarely be selected. Instead, consideration must be given to the relative amount of additional settlement or compaction gained for additional passes as

indicated by the slope of the settlement versus number of passes curve. Figures 12-1 through 12-4 show that in most (but not all) instances the curves tend to decrease in slope with number of passes even though the decrease may be relatively subtle. These figures also offer some comparative cases among different types of rollers. In addition, visual observations of the inspection trench and results of in situ density and percolation tests must be factored in to make a judgment based on the highest return for the effort put forth and the actual needs of the embankment, i.e., height, seismic risk, etc. More compaction can almost always be obtained by more passes, but the price that must be paid to achieve it becomes increasingly high and perhaps unjustified.

12-4. Gradation Data

Gradation data are usually obtained on the rockfill material before spreading and compaction and after compaction. Intermediate gradations have also been taken such as after certain numbers of passes of the roller or even after spreading if alternate spreading operations are under consideration to reduce material breakdown such as between rubber-tired equipment and the crawler tractor. Figures 12-8 through 12-12 show typical before- and after-compaction gradation curves. These figures were also selected because they compare vibratory rollers with 45-Mg (50-ton) rubber-tired rollers.

12-5. In Situ Density Data

In considering in situ density data, it is well to bear in mind the previous discussions concerning the major source of the shear strength between a sound rockfill and that which contains considerable fines. For sound rock, the key to its strength is interlocking among the larger particles which are segregated toward the bottom of the lift even if fines are generated on the surface of the lift. For materials containing appreciable fines mixed throughout the material such that the larger rocks tend to be separated and “float” within the finer fraction, the shear strength and compressibility will reflect the density of the mass much more directly. For fill composed of sound rock, in situ density numbers are of lesser interest than the observation that the lifts are expectably segregated and stratified with interlocking of the larger particles. For “dirtier” rockfill where the fines will control the strength and compressibility, variability of in situ density with type of roller, number of passes, loose-lift thickness, and use of water is of much greater importance. The Seven Oaks Dam test fill program included an unusually large number of 1.2-m (4-ft) diameter, water-volume, ring density tests.

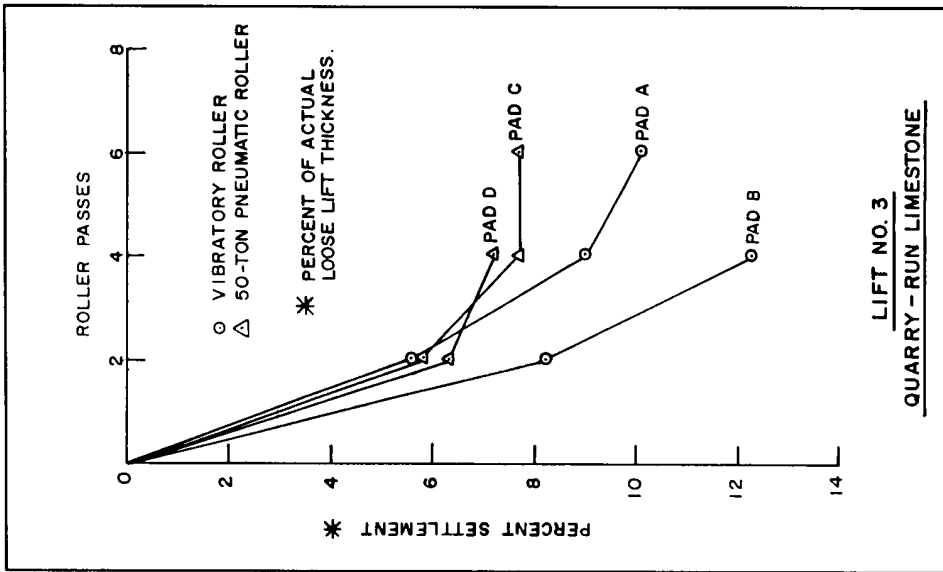

Figure 12-2. Percent settlement versus roller passes, lift 3, test fill 4A, Cerrillos Dam

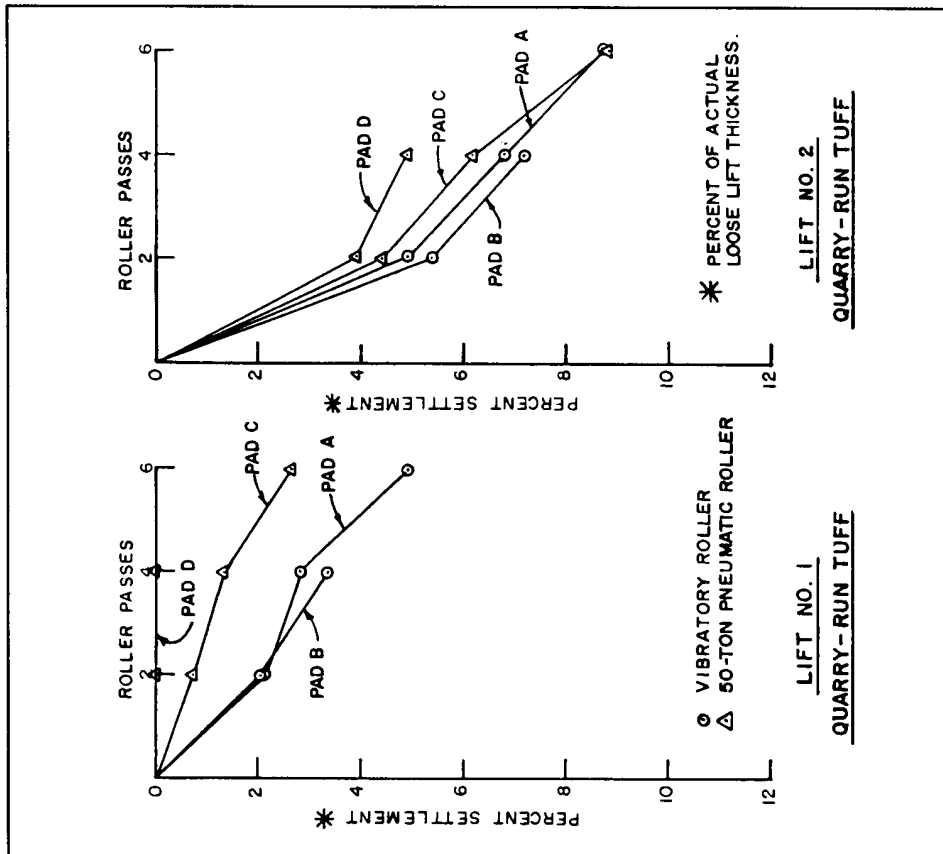

Figure 12-1. Percent settlement versus roller passes, lifts 1 and 2, test fill 4A, Cerrillos Dam

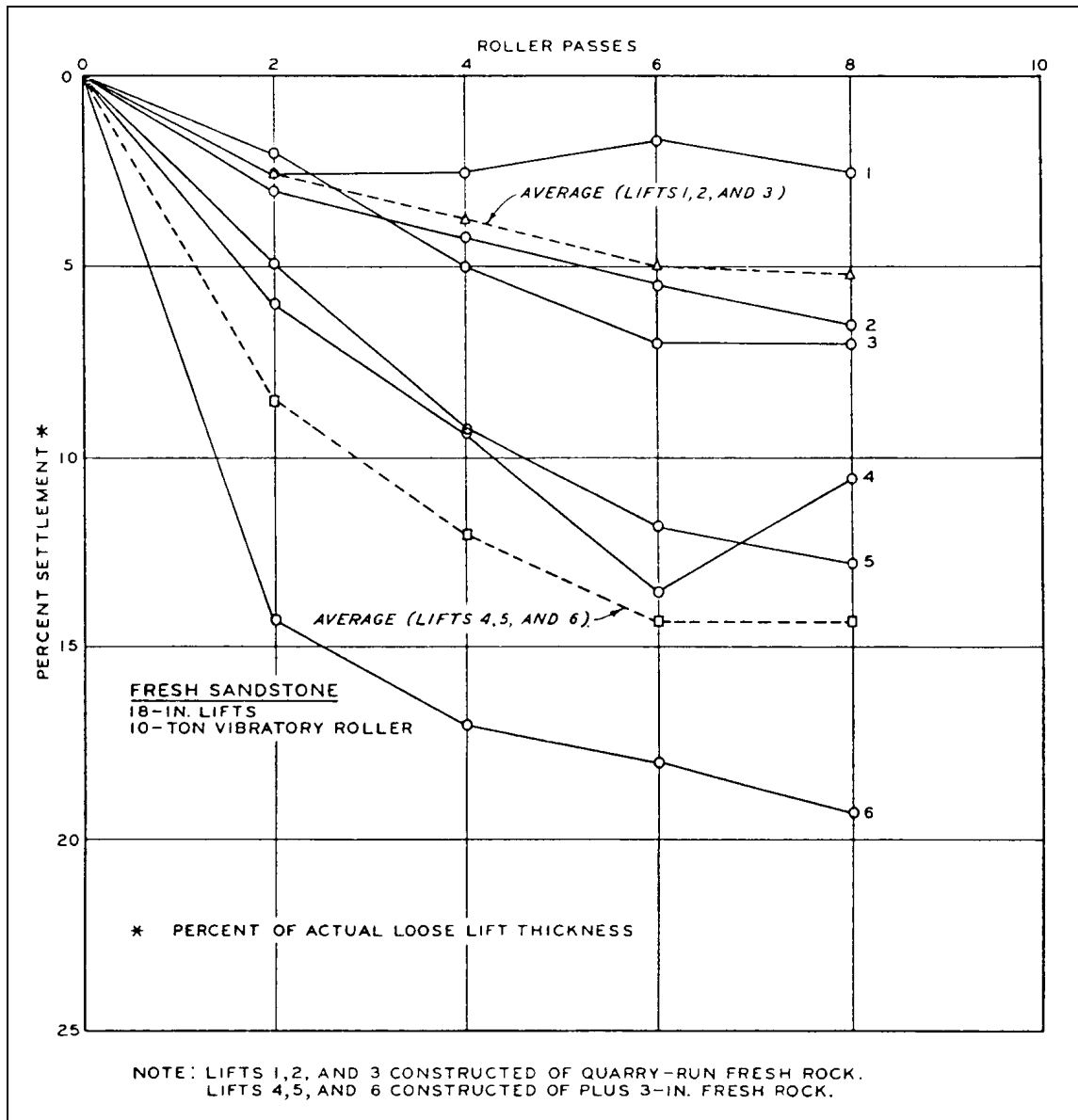

Figure 12-3. Percent settlement versus roller passes, Gilham Dam test fill

The portion of these data given in Figures 12-13 through 12-18 show in situ densities achieved by different rollers for a 45.7-cm (18-in.) lift thickness over a range in number of passes for the variety of rock types involved. Figures 12-13 through 12-15 show the actual results of the in situ density tests. The range of densities indicated are typical of those seen for rockfill materials. Because of the variation in the gradations of the full-scale material derived from the density tests including a range in maximum particle size, the Los Angeles District personnel astutely realized that direct comparison of the density values of Figures 12-13 through 12-15 was not valid. To compare the performance of the rollers on a common

basis, it was decided to correct the fill density test values to those corresponding to the minus 7.6-cm (3-in.) and minus 3.8-cm (1.5-in.) fractions of each fill density sample. The correction was by use of the equation given in EM 1110-2-1911, Appendix B (see paragraph 11-2c, equation 11-1) where the gradation curve for each full-scale density sample was used to obtain the percent coarse fraction and percent fine fraction. In correcting the total material density to that of the minus 7.6-cm (3-in.) fraction within it, the percent coarse fraction "c" was the percent retained on the 7.6-cm (3-in.) sieve and the percent fine fraction "f" was then 1-c. Likewise, to correct

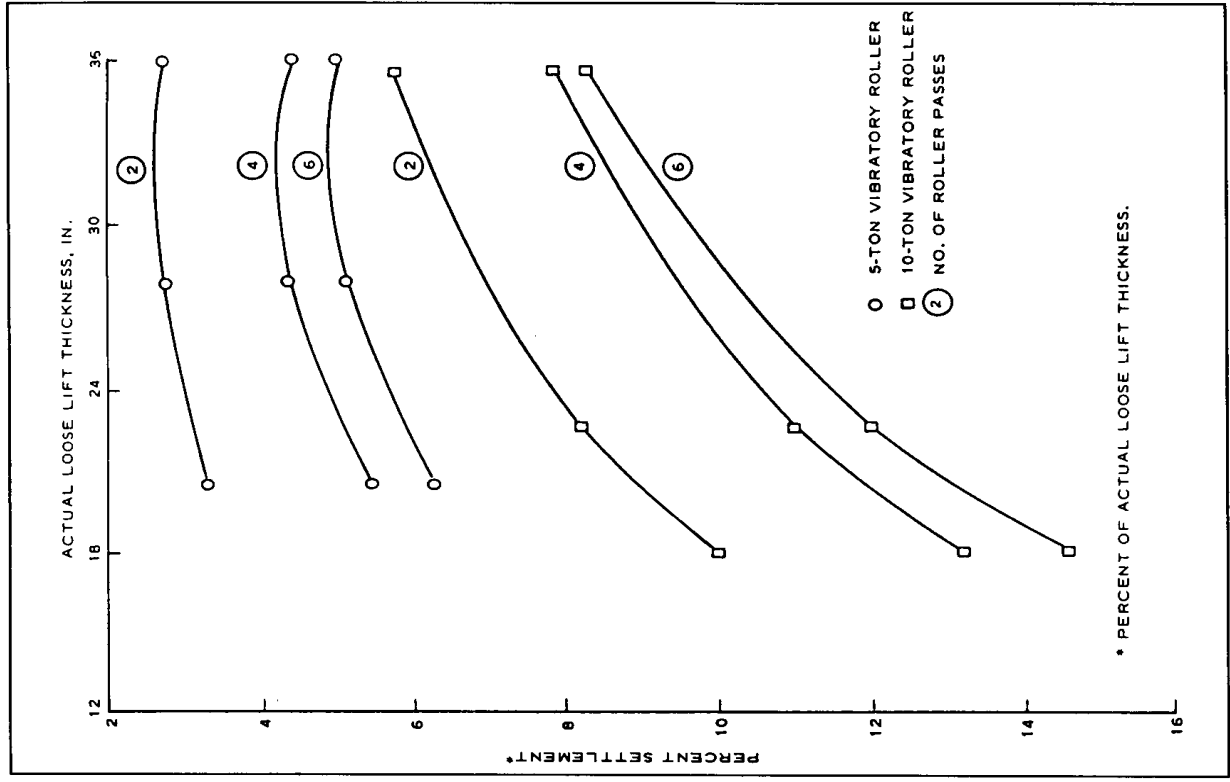

Figure 12-5. Percent settlement versus actual loose-fit thickness, test fill series 2, Cougar Dam

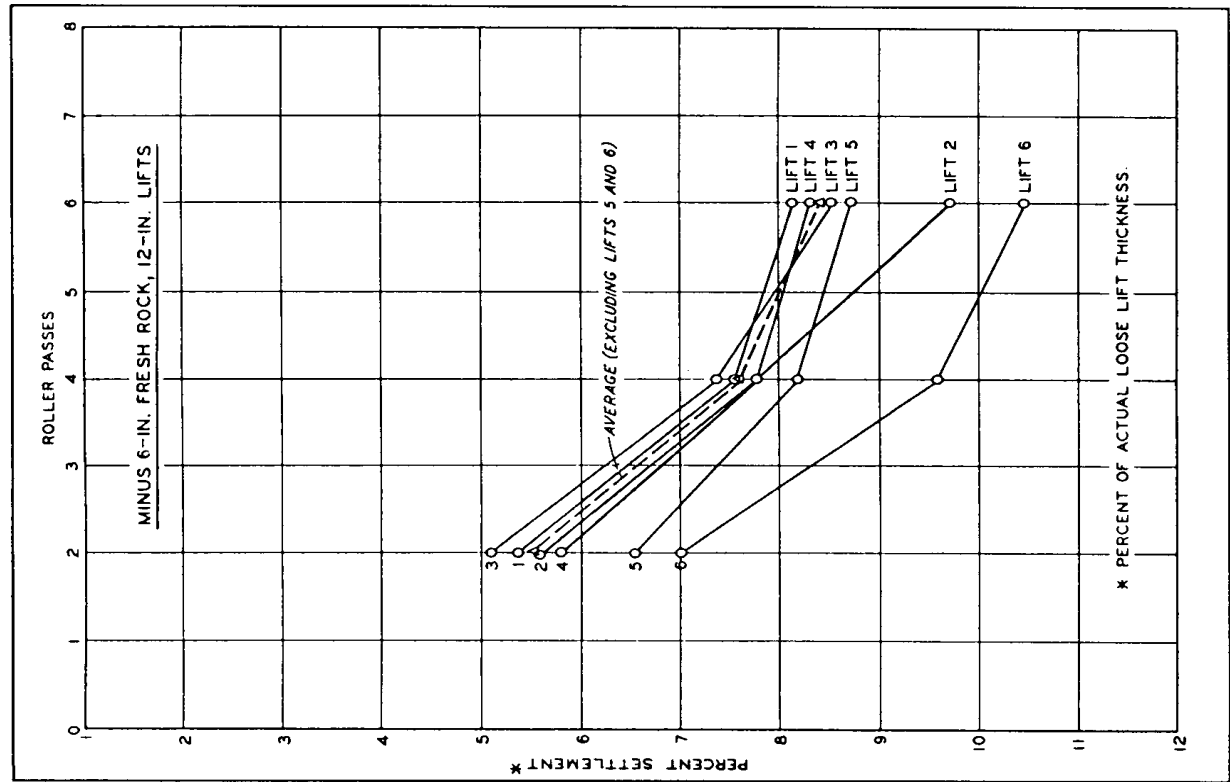

Figure 12-4. Percent settlement versus roller passes, test fill 3, New Melones Dam

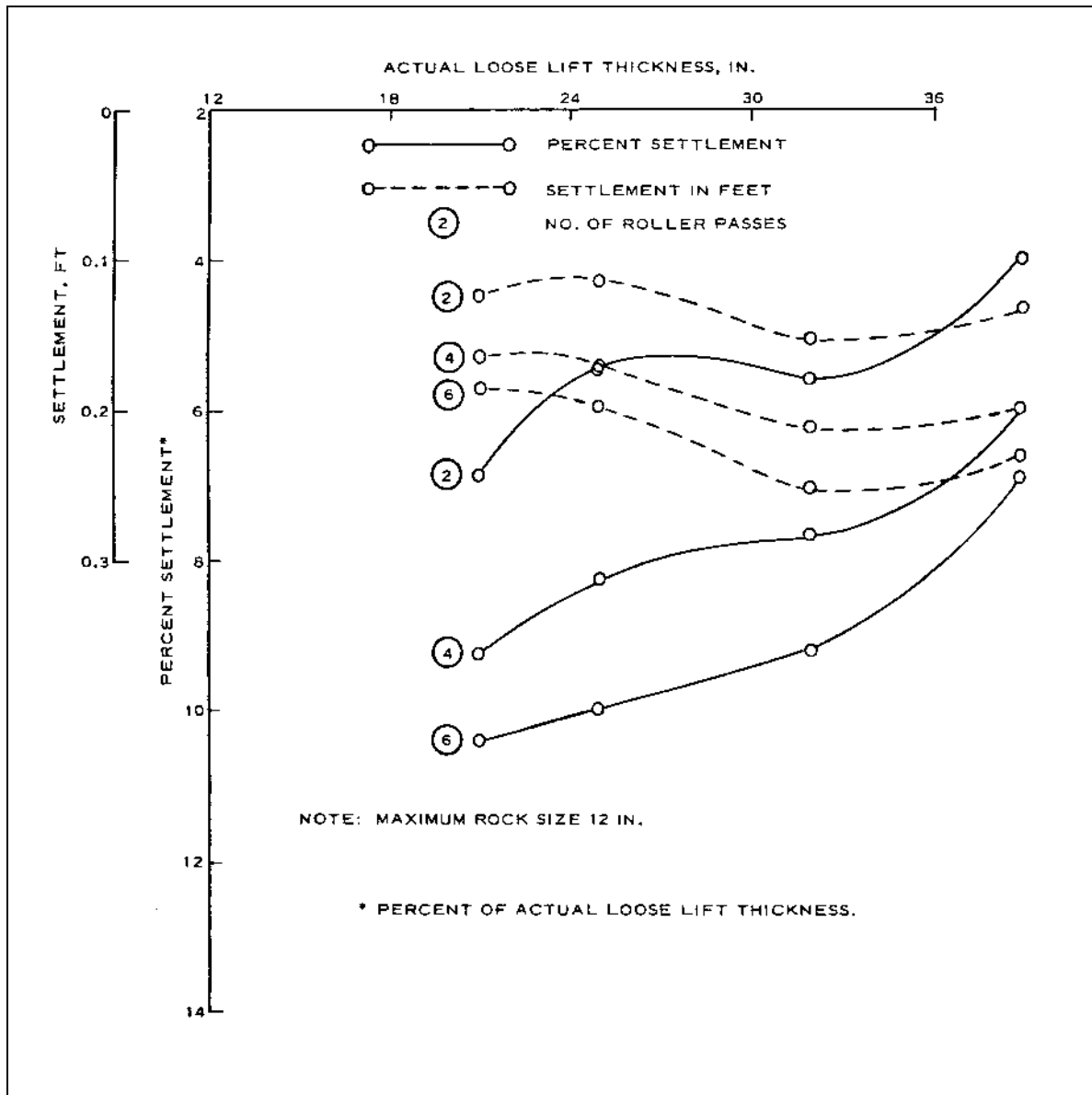

Figure 12-6. Percent settlement versus actual loose-fit thickness, test fill series 3, Cougar Dam

the total material density to that of the minus 3.8-cm (1.5-in.) fraction within it, the percent coarse fraction "c" was that retained on the 3.8-cm (1.5-in.) sieve. Figures 12-16 through 12-18 show the data of Figures 12-13 through 12-15 corrected to the densities of the minus 7.6-cm (3-in.) fractions. It is seen that the 45.3-Mg (50-ton) rubber-tired roller performed about as well as the vibratory rollers. As a matter of interest, the recommended compaction procedure for the rockfill of Seven Oaks Dam shell became a 45.7-cm (18-in.) loose lift thickness and 6 passes of the 9.1-Mg (10-ton) vibratory roller. For "dirtier" rockfill of the same parentage as the

shell materials, a rockfill transition zone was provided downstream of the core of the dam, and its recommended compaction was 30.5-cm (12-in.) loose lifts and 4 passes of the 9.1-Mg (10-ton) vibratory roller.

12-6. Inspection Trench

Figures 12-19 through 12-22 are provided as examples of inspection trench observations. Figure 12-19 shows the sound rockfill for New Melones Dam where the important interlocking of the larger particles is evident with

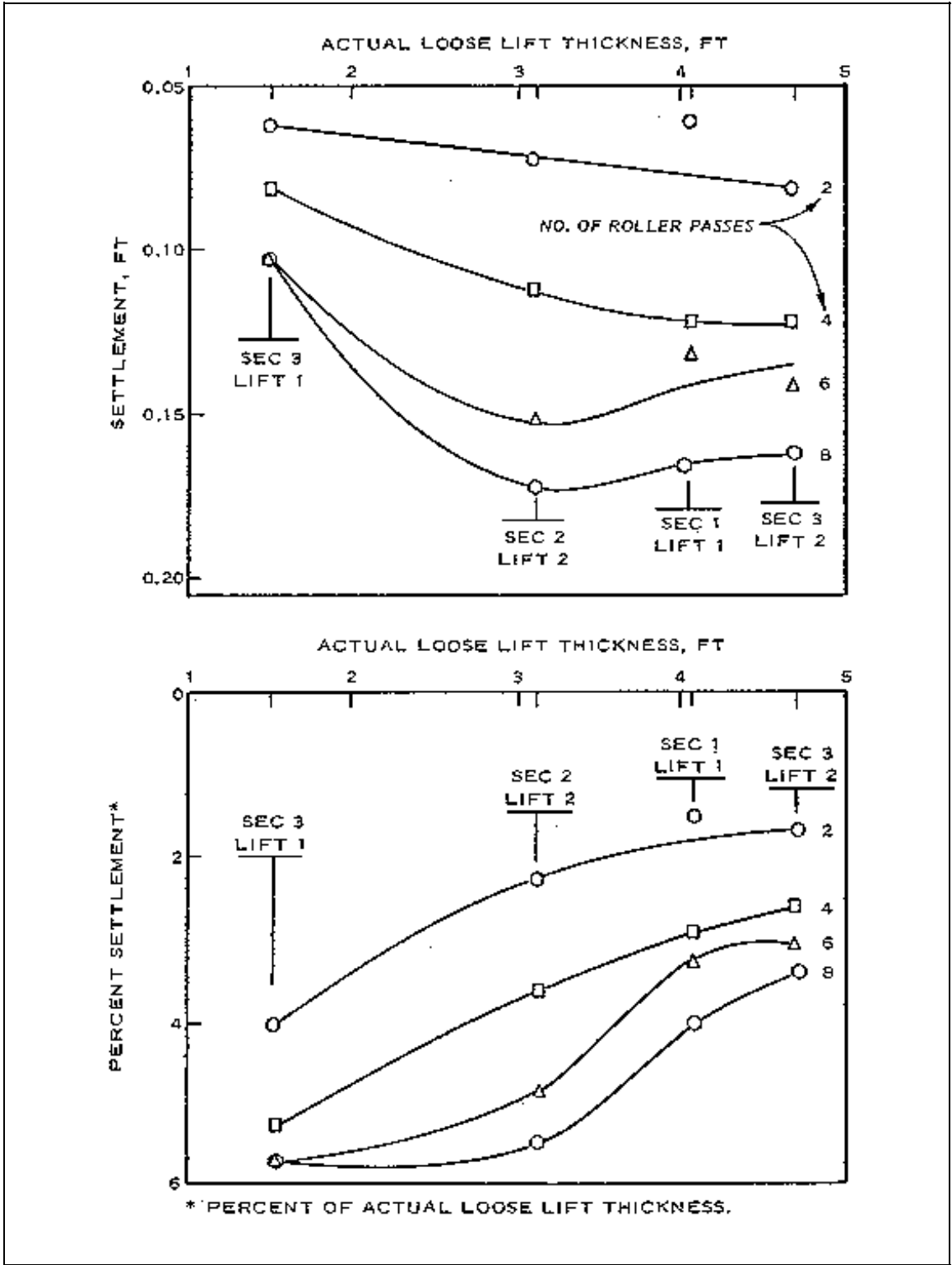

Figure 12-7. Percent settlement versus actual loose-fit thickness, Laurel Dam test fill

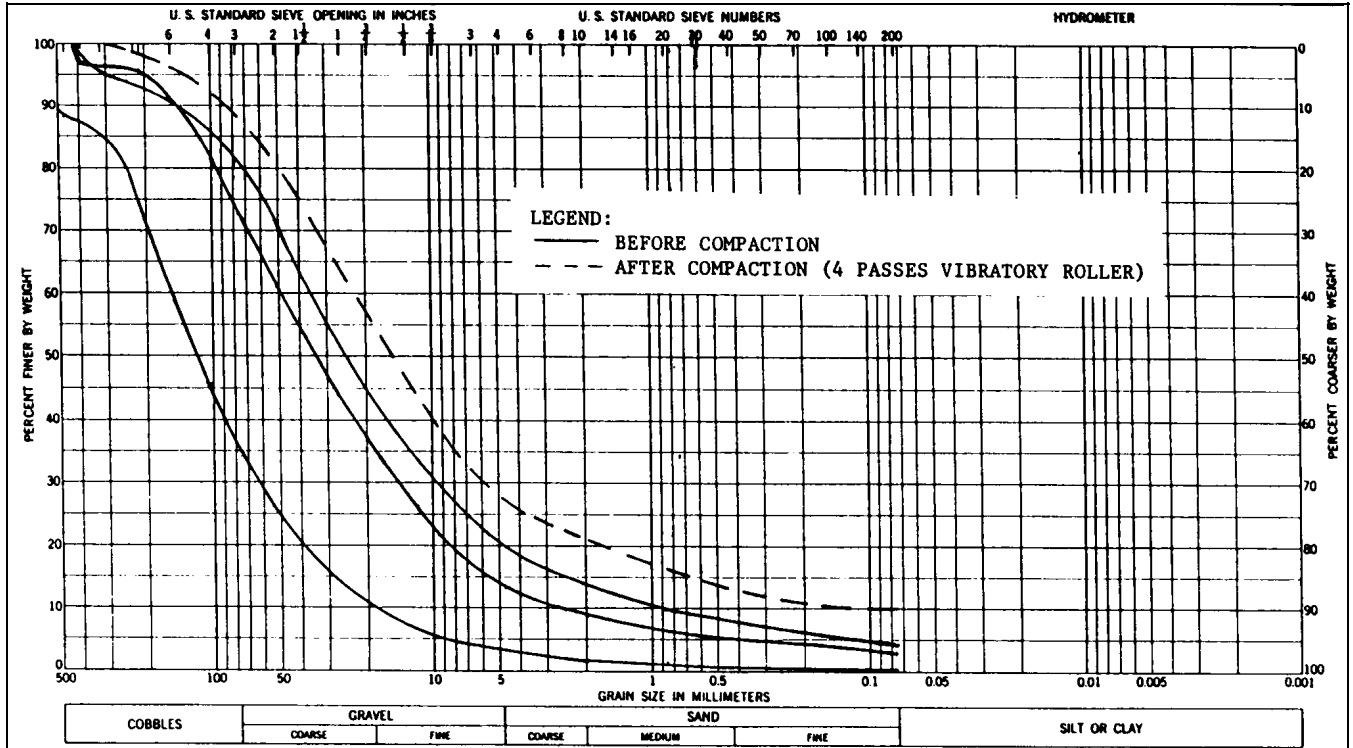

Figure 12-8. Before and after-compaction gradations after 4 passes of the vibratory roller, quarry-run siltstone, Cerrillos Dam

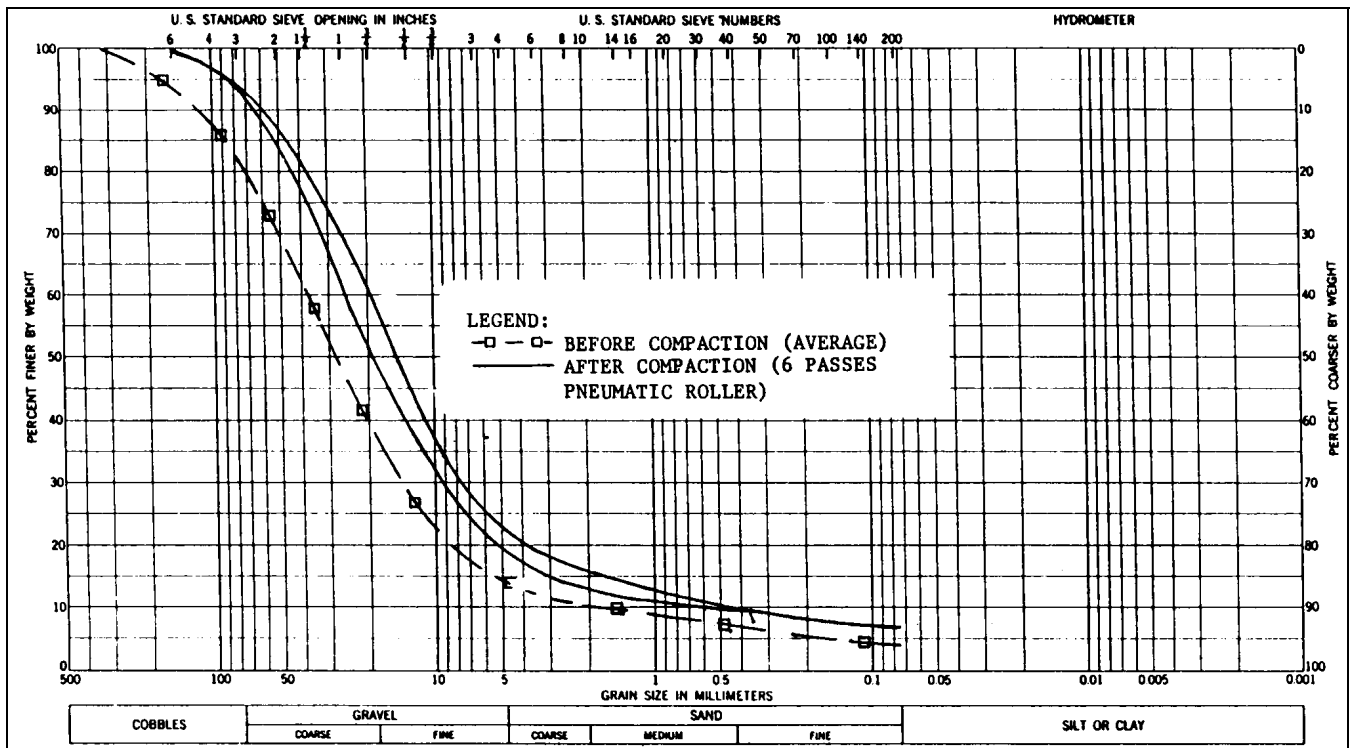

Figure 12-9. Before and after-compaction gradations after 6 passes of the pneumatic roller, quarry-run siltstone, Cerrillos Dam

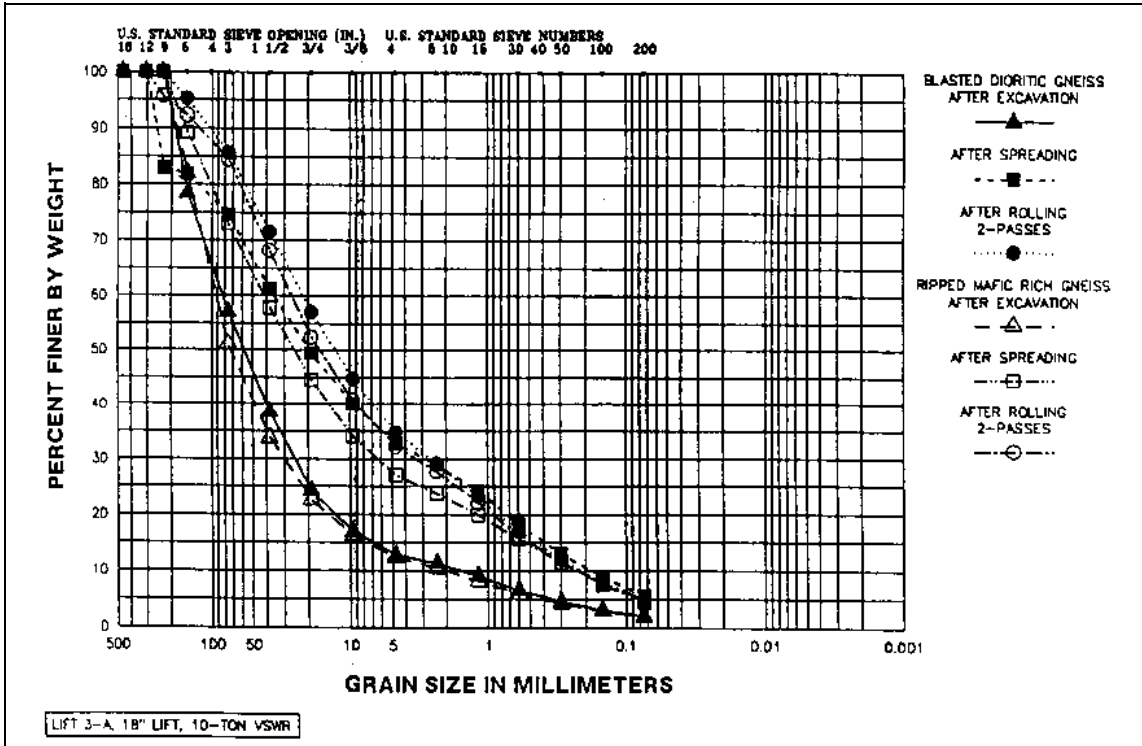

Figure 12-10. Change in gradation after 2 passes of 9.1-metric ton (10-ton) vibratory roller, 45.7-cm (18-in.) lift, Seven Oaks Dam materials

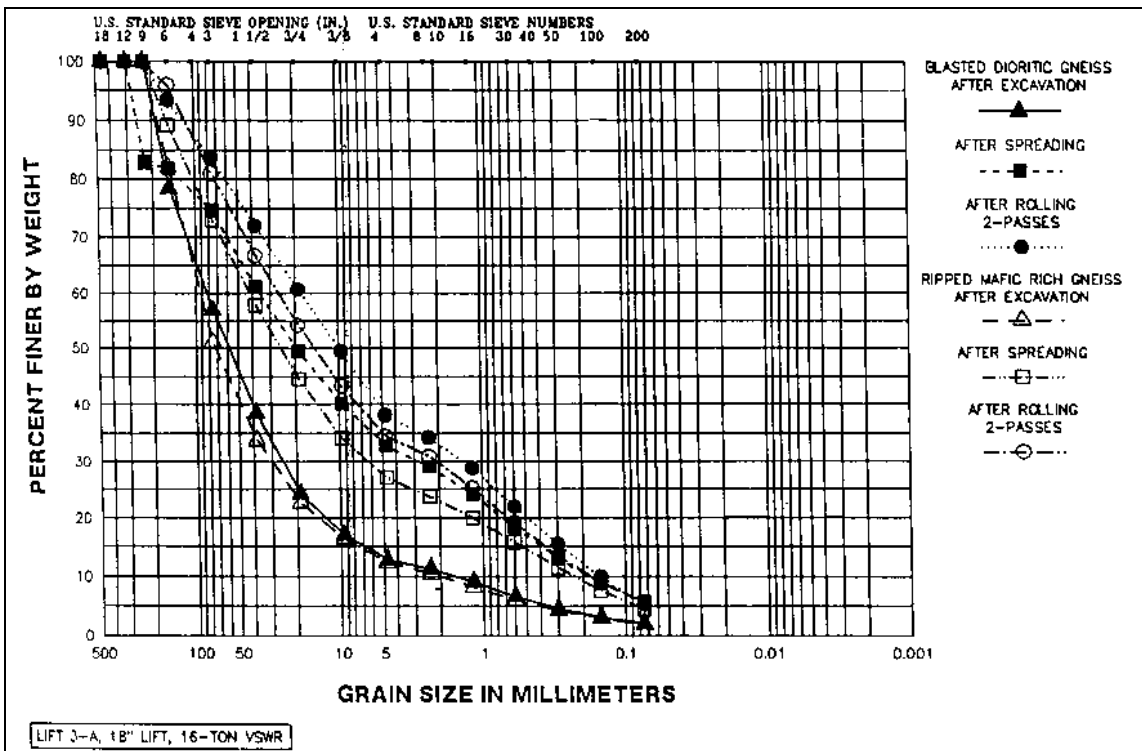

Figure 12-11. Change in gradation after 2 passes of 14.5-metric ton (16-ton) vibratory roller, 45.7-cm (18-in.) lift, Seven Oaks Dam materials

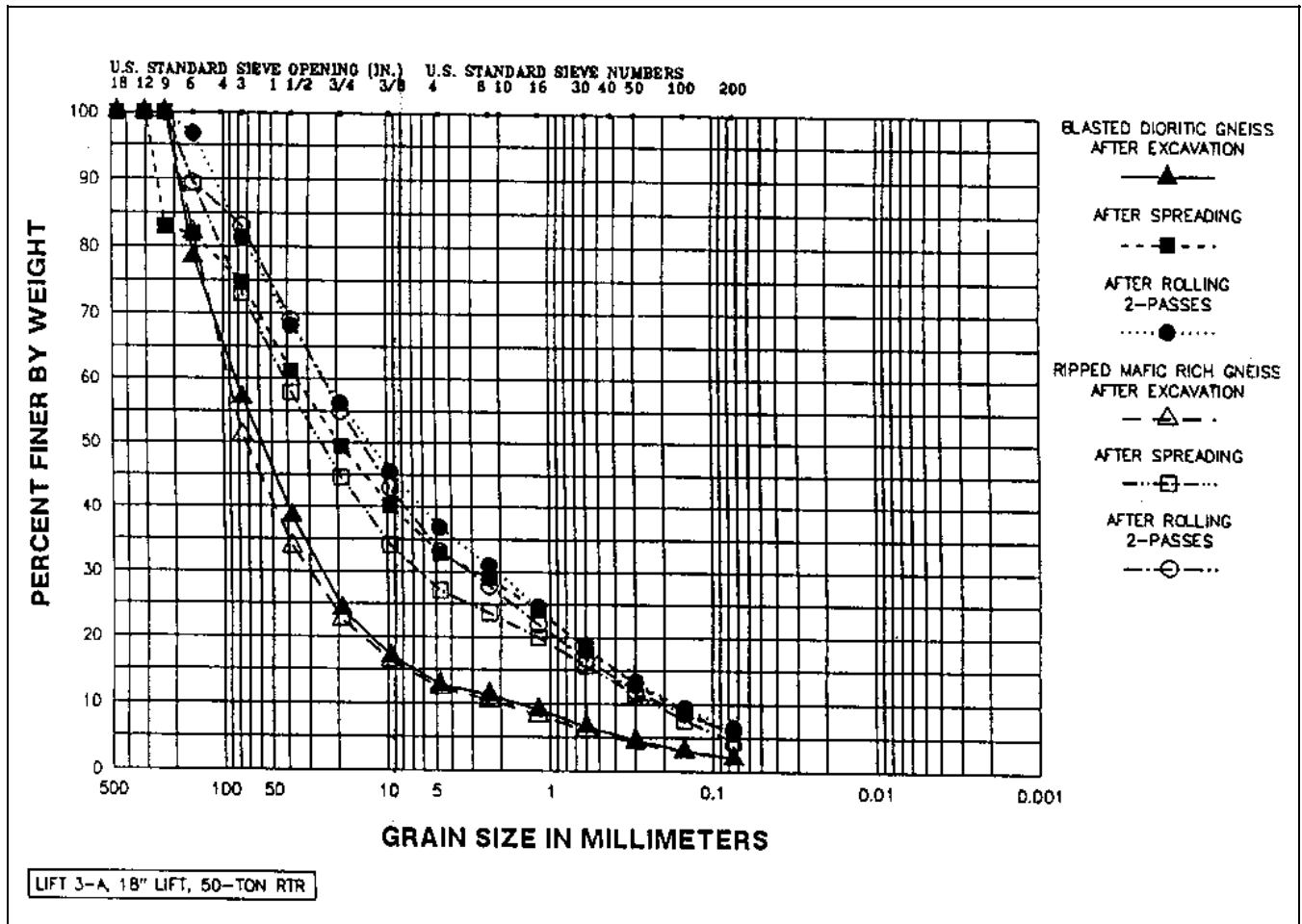

Figure 12-12. Change in gradation after 2 passes of 45.4-metric ton (50-ton) rubber-tired roller, 45.7 cm (18-in.) lift, Seven Oaks Dam materials

relatively little fines distributed throughout. Figure 12-20 shows a New Melones material with considerable fines where the overall uniform density with no significant segregation is apparent. It is also noted from the lower photograph of Figure 12-20 that the lifts are very nicely bonded as indicated by no indication of lift boundary other than the lime lift marker material (very thin, horizontal white seam across the photo). Figures 12-21 and 12-22 are from the test fills for Cerrillos Dam and also show the relative compactness and uniformity of that material containing appreciable fines.

12-7. Test Fill Report

After completion of the test fill program, a comprehensive formal report should be prepared as a project Design Memorandum in its own right or as a major portion of a Design Memorandum. Where a test quarry program was also performed in conjunction with the test fill program, the comprehensive report should treat both subjects. A typical test quarry and test fill report outline is given in Table 12-1. The test quarry portion of Table 12-1 was previously suggested in Table 7-1.

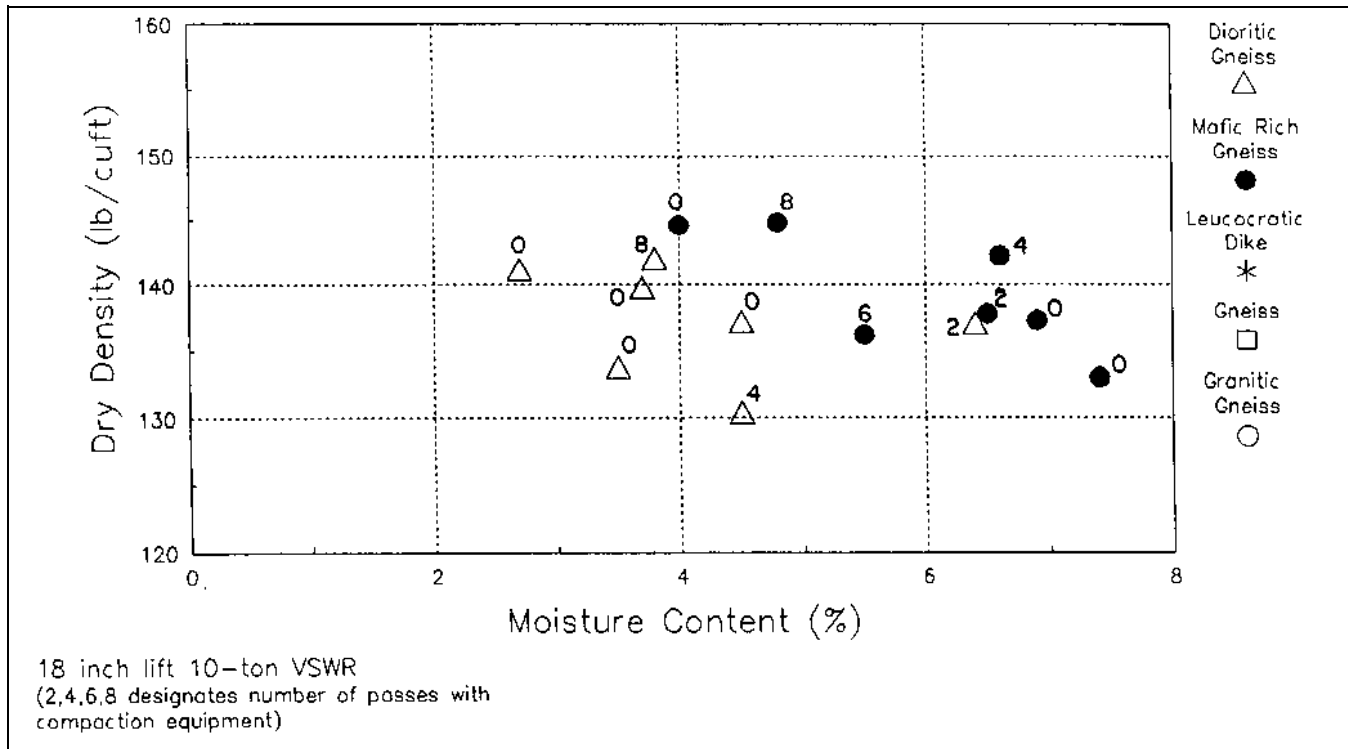

Figure 12-13. In situ density tests, 45.7-cm (18-in.) lift, 9.1-metric ton (10-ton) vibratory roller, Seven Oaks Dam materials

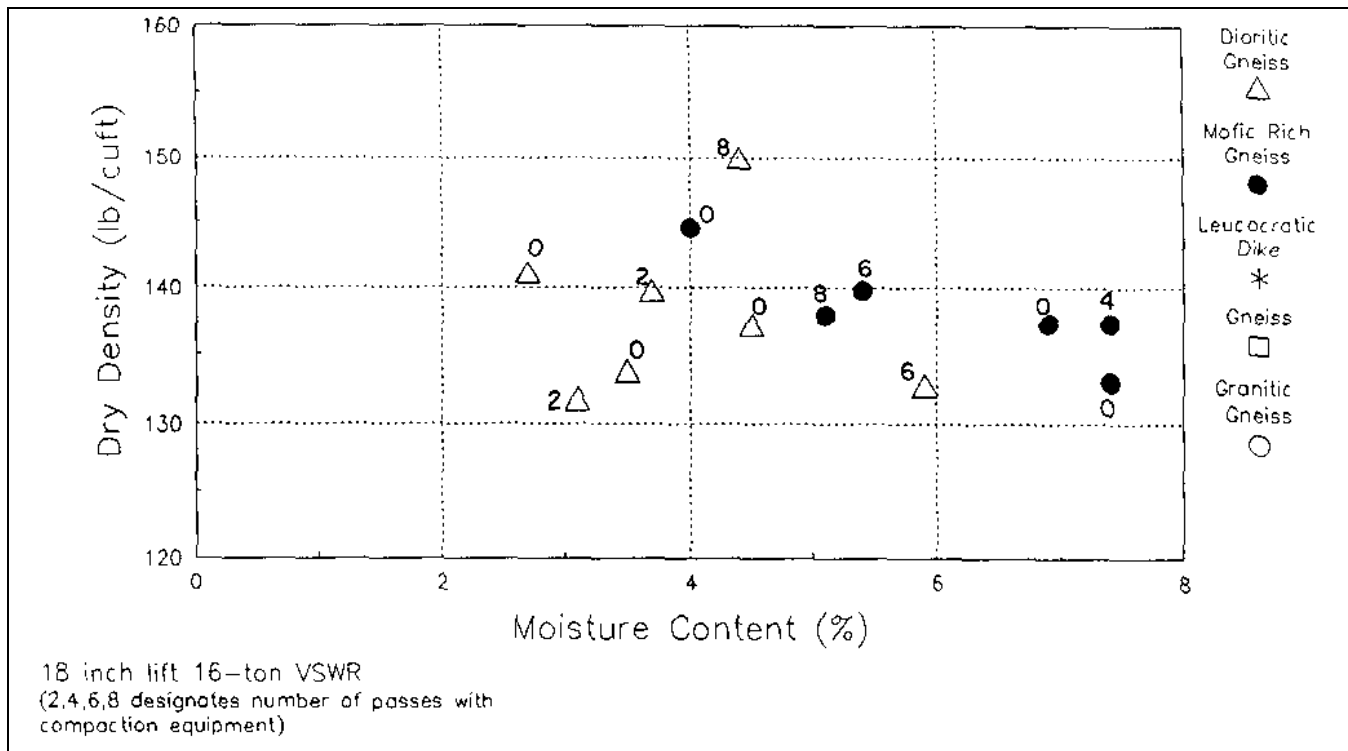

Figure 12-14. In situ density tests, 45.7-cm (18-in.) lift, 14.5-metric ton (16-ton) vibratory roller, Seven Oaks Dam materials

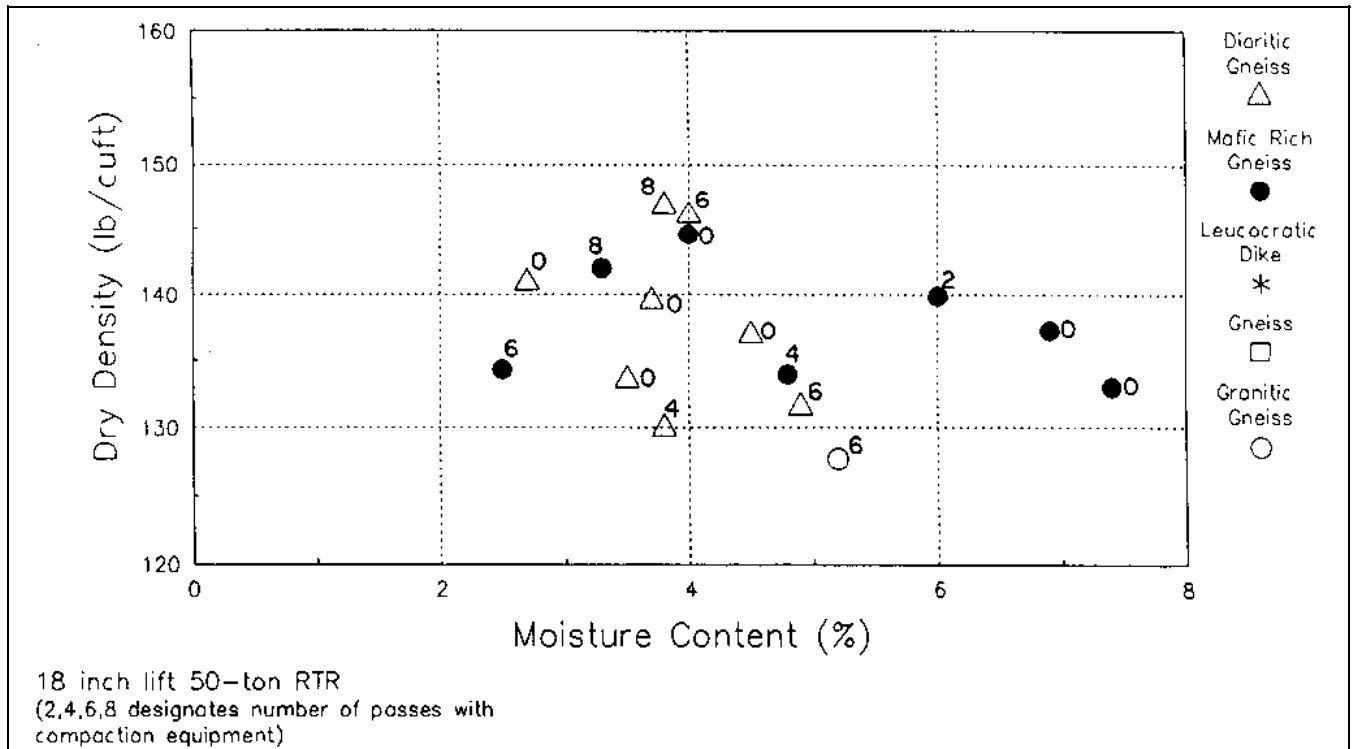

Figure 12-15. In situ density tests, 45.7-cm (18-in.) lift, 45.4-metric ton (50-ton) rubber-tired roller, Seven Oaks Dam materials

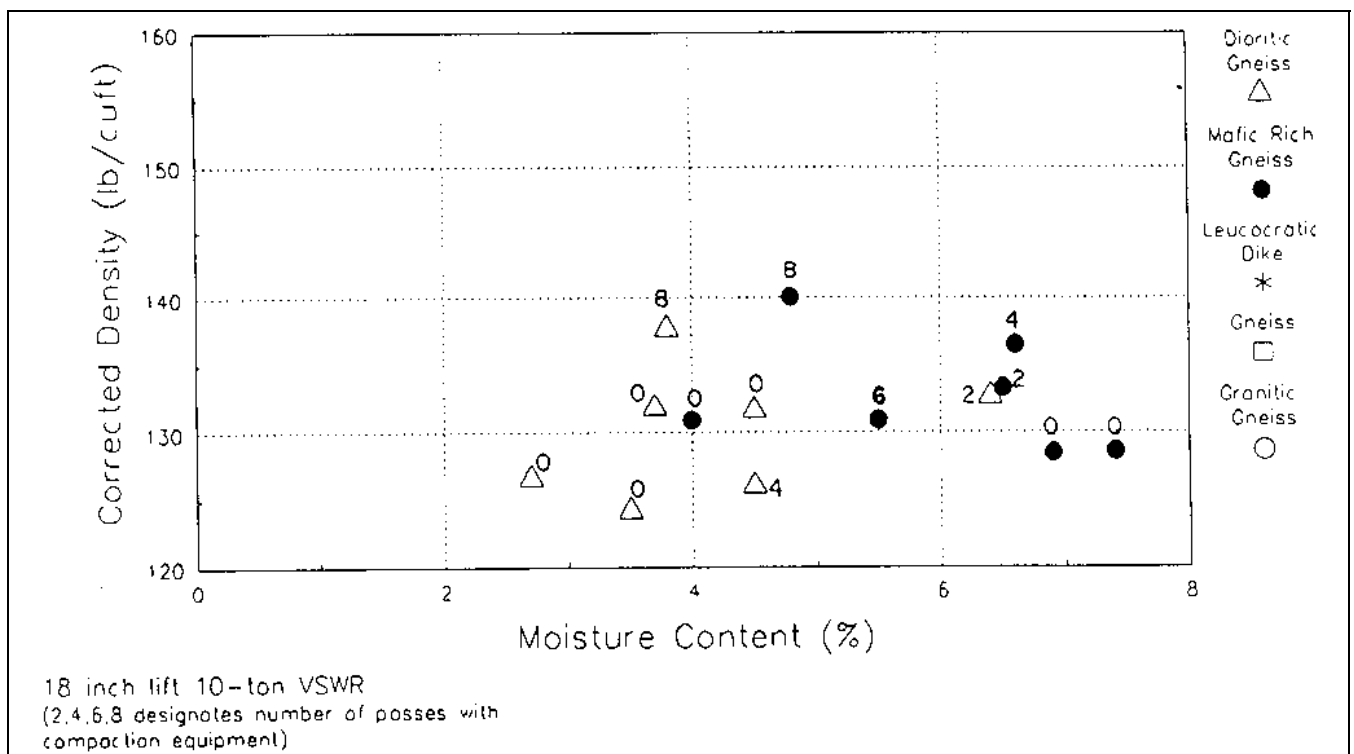

Figure 12-16. Corrected in situ densities, 45.7-cm (18-in.) lift, 9.1-metric ton (10-ton) vibratory roller, Seven Oaks Dam materials

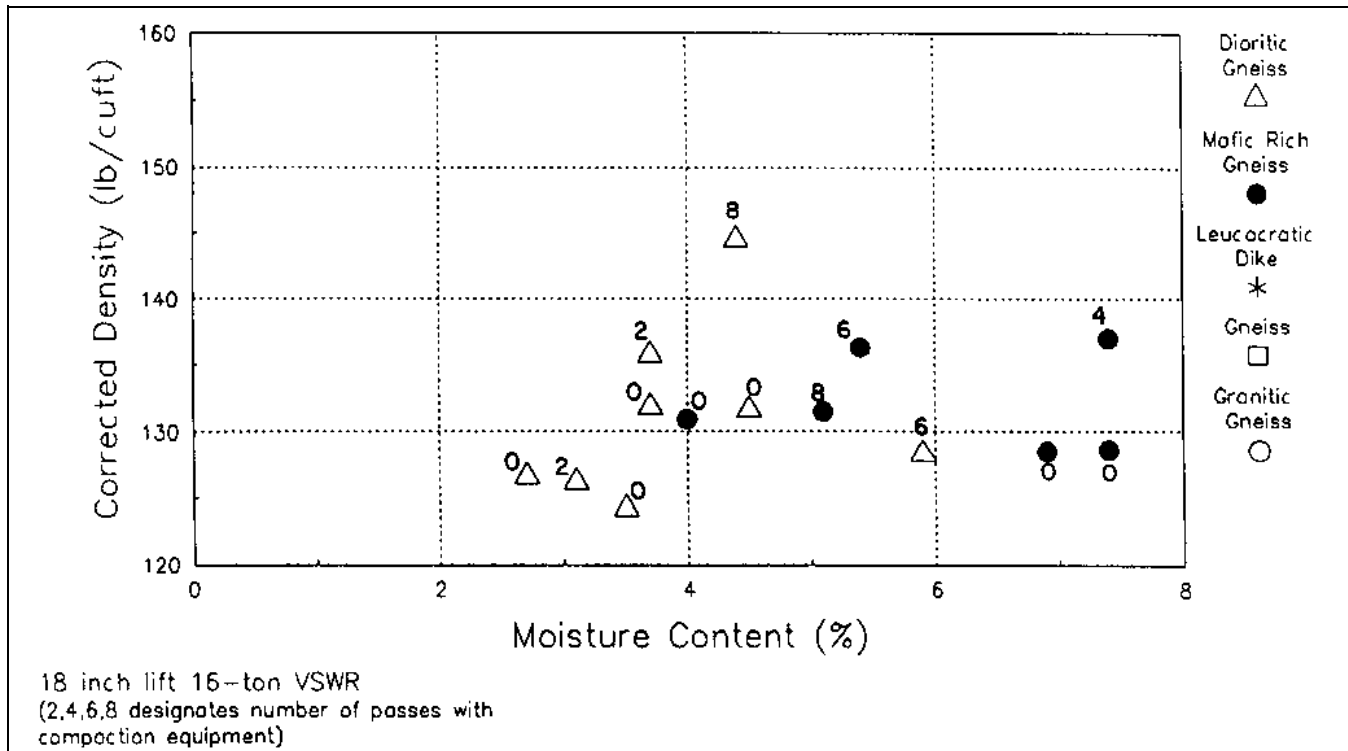

Figure 12-17. Corrected in situ densities, 45.7-cm (18-in.) lift, 14.5-metric ton (16-ton) vibratory roller, Seven Oaks Dam materials

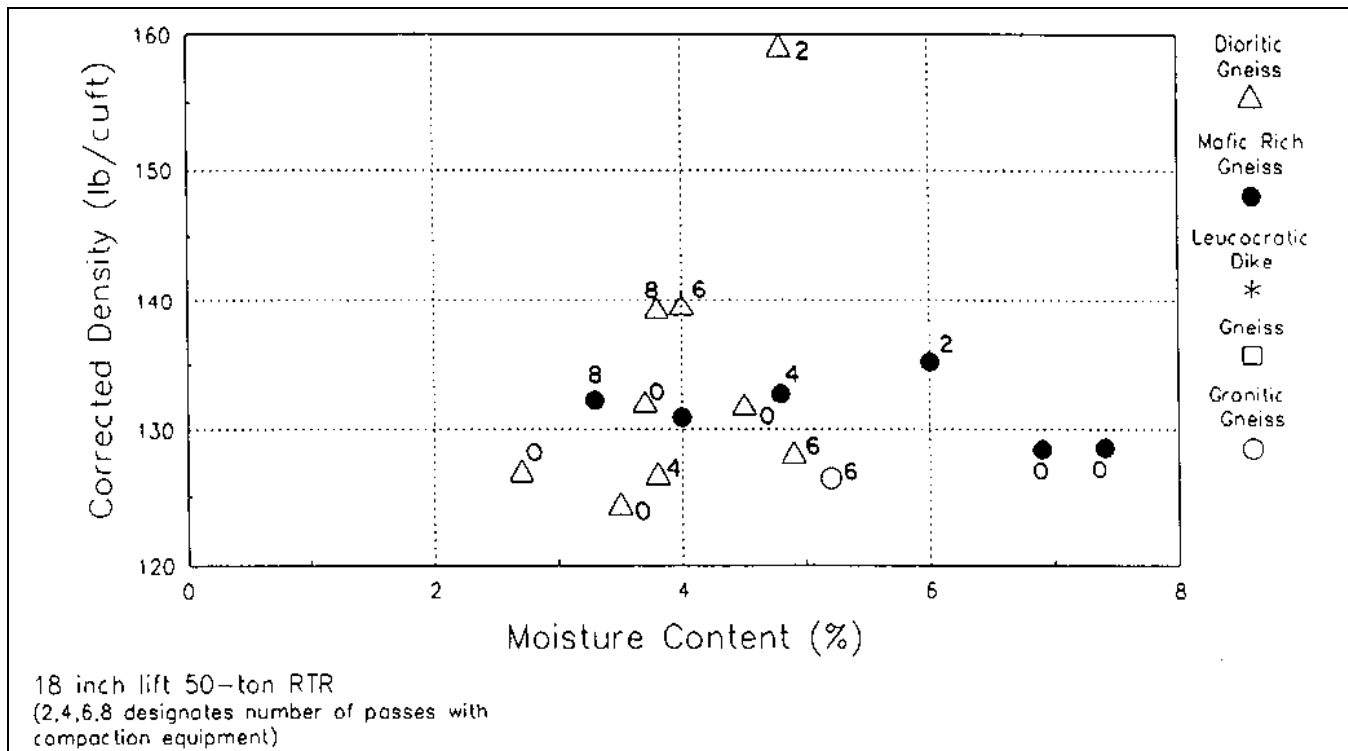

Figure 12-18. Corrected in situ densities, 45.7-cm (18-in.) lift, 45.4-metric ton (50-ton) rubber-tired roller, Seven Oaks Dam materials



Figure 12-19. Photographs of sound rockfill, New Melones Dam test fill inspection trench



Figure 12-20. Photographs of rockfill containing appreciable fines, New Melones Dam test fill inspection trench

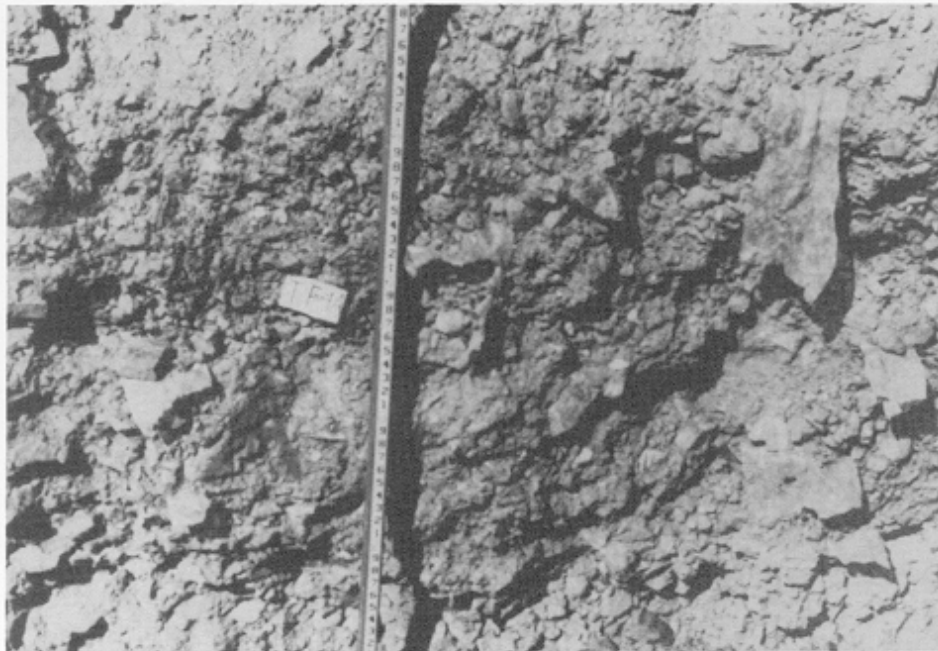

Figure 12-21. Photographs of rockfill containing appreciable fines, Cerrillos Dam test fill No. 4 inspection trench

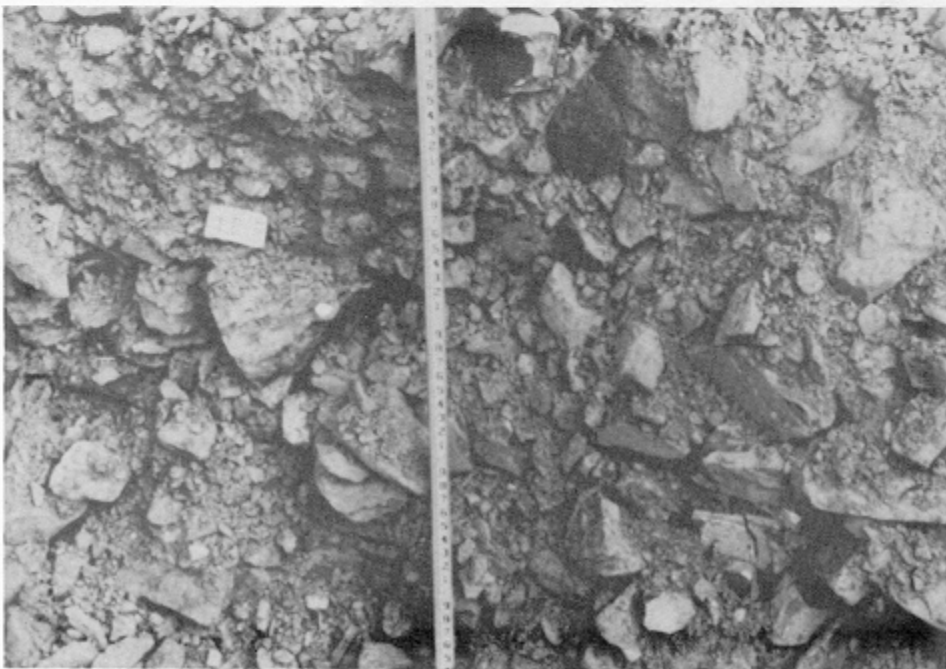

Figure 12-22. Photographs of rockfill containing appreciable fines, Cerrillos Dam test fill No. 5 inspection trench

Table 12-1
Typical Test Quarry and Test Fill Report Outline

1. Executive Summary
2. Table of Contents
3. Section 1 - Introduction
 - a. Authorization
 - b. Scope and purpose
 - c. Location of the project
4. Section 2 - Site Geology
 - a. Topography
 - b. Geology
5. Section 3 - Project Plan
 - a. Project features utilizing rockfill
 - b. Expected borrow sources and locations
6. Section 4 - Site Selection for Test Quarry and Test Fill
 - a. General discussion of site selection factors and judgments including borehole information
 - b. Selected locations of test quarry and test fill
 - c. General preliminary site preparation such as removal of and destination of overburden, access road aspects, etc.
7. Section 5 - Test Quarry
 - a. Test quarry design and objectives
 - 1) Discussion of objectives
 - 2) Overview of site selection criteria
 - 3) Thorough presentation of design including layout and slope stability
 - b. Geological conditions in the test quarry
 - c. Description of each test blast
 - 1) Rock type and condition
 - 2) Hole pattern
 - 3) Delay pattern
 - 4) Hole depths and loading design
 - 5) Explosives, detonators, and delays
 - 6) Blasted rock mass description
 - 7) Quarry-run gradation
 - 8) Laboratory tests and results
 - 9) Conclusions
 - d. Drilling, loading, and hauling equipment and procedures
 - e. Description of the results of each presplit slope blast
 - 1) Rock type and condition
 - 2) Presplit hole and explosive charge configuration
 - 3) Presplit slope condition
 - 4) Rock joint analysis and slope stability
 - 5) Conclusions

(Continued)

Table 12-1 (Concluded)

- f. Rock processing results
 - 1) Description of processing objective
 - 2) Description of rock processing equipment
 - 3) Results of processing each rock type and condition
 - 4) Gradations and particle shapes
 - 5) Degradation during each stage of processing
 - 6) Laboratory tests and results
 - g. Conclusions and recommendations
8. Section 6 - Test Fill
- a. Description of the test fill program including materials, layout, and compaction equipment to be assessed
 - b. Description of tests and measurements to be performed
 - 1) Description of test procedures and schedule of tests
 - 2) Locations including settlement grid layout
 - c. Foundation preparation
 - 1) Description of the foundation
 - 2) Treatment prior to leveling pad construction (if any) such as special rolling to reduce compressibility
 - 3) Materials and construction of leveling pad, including equipment types
 - 4) Justification for, locations of, descriptions of, and installation procedures for settlement plates
 - d. Construction
 - e. Field tests and measurements, i.e., in situ densities, gradations, etc.
 - f. Laboratory tests and results (if any)
 - g. Analysis and discussion of data
9. Section 7 - Inspection Pits or Trenches
- a. Description of inspection pits or trenches and locations, method of excavation
 - b. Discussion of observations and any sampling
10. Section 8 - Conclusions and Recommendations
- a. Conclusions including lessons learned
 - b. Recommendations

APPENDICES -- Laboratory Test Sheets, Boring Logs, Field Gradation Test Results, Description of Rock Processing Equipment, Photographic Documentation of All Aspects of Test Quarry and Test Fill, etc.

Appendix A References

A-1. Required Publications

TM 5-332

Pits and Quarries

ER 1110-2-1150

Engineering and Design for Civil Works Projects

ER 1165-2-132

Hazardous, Toxic, and Radioactive Waste (HTRW) Guidance for Civil Works Projects

EM 385-1-1

Safety and Health Requirements Manual

EM 1110-1-1802

Geophysical Exploration

EM 1110-1-1804

Geotechnical Investigations

EM 1110-2-1906

Laboratory Soils Testing

EM 1110-2-1908

Instrumentation of Earth and Rock-Fill Dams

EM 1110-2-1911

Construction Control for Earth and Rock-Fill Dams

EM 1110-2-2300

Earth and Rock-Fill Dams - General Design and Construction Considerations

EM 1110-2-2302

Construction with Large Stone

EM 1110-2-3800

Systematic Drilling and Blasting for Surface Excavations

ETL 1110-1-145

Guidance on Use of Rock Quality Designation

A-2. Related Publications

American Geological Institute 1989

AGI Data Sheets for Geology in the Field, Laboratory, and Office, Third Edition

American Society for Testing and Materials 1994a

1994 ASTM Book of Standards, Vol. 04.09, "Soil and Rock (II): D 4943 - latest; Geosynthetics," Philadelphia, PA.

American Society for Testing and Materials 1994b

1994 ASTM Book of Standards, Vol. 04.02, "Concrete and Aggregates," Philadelphia, PA.

American Society for Testing and Materials 1994c

1994 ASTM Book of Standards, Vol. 04.08, "Soil and Rock (I): D 420 - D 4914," Philadelphia, PA.

American Society for Testing and Materials 1994d

Designation D 5519-93, "Test Method for Particle Size Analysis of Natural and Man-Made Riprap Materials," (to appear in Vol 04.08 of the *1995 ASTM Annual Book of Standards*), Philadelphia, PA.

American Society for Testing and Materials 1988

ASTM Special Technical Publication (STP) 984. 1988. "Rock Classification Systems for Engineering Purposes," L. Kirkaldie, Editor, Philadelphia, PA.

Bertram 1973

Bertram, G. E. 1973. "Field Tests for Compacted Rock-fill," *Embankment Dam Engineering, Casagrande Volume*, edited by R. C. Hirshfeld and S. J. Poulos, John Wiley and Sons, New York, NY, pp. 1-19.

Bieniawski 1975

Bieniawski, Z. T. 1975. "The Point Load Test in Geotechnical Practice," *Engineering Geology*, Vol. 9, Elsevier Scientific Publishing Co., Amsterdam, Netherlands.

Brady and Brown 1985

Brady, B. H. G. and Brown, E. T. 1985. *Rock Mechanics for Underground Mining*, Allen and Unwin Publishers.

Compton 1962

Compton, R. R. 1962. *Manual of Field Geology*, John Wiley and Sons, New York, NY.

Cooke 1960

Cooke, J. B. 1960. "Symposium on Rockfill Dams," *Transactions*, ASCE, Vol 104.

Cooke 1984

Cooke, J. B. 1984 (Oct). "Progress in Rockfill Dams," *Journal of Geotechnical Engineering*, Vol. 110, No. 10, ASCE.

Cooke 1990

Cooke, J. B. 1990 (May). "Rockfill and Rockfill Dams," Second Annual Stanley D. Wilson Memorial Lecture, University of Washington, Shannon & Wilson, Inc., Seattle, WA.

Donaghe and Torrey 1985

Donaghe, R. T. and Torrey, V. H. 1985 (Sept). "Strength and Deformation Properties of Earth-Rock Mixtures," Technical Report GL-85-9, U.S. Army Engineer Waterways Experiment Station, Vicksburg, MS.

Hammer and Torrey 1973

Hammer, D. P. and Torrey, V. H. 1973 (Mar). "Test Fills for Rock-Fill Dams," Miscellaneous Paper S-73-7, U.S. Army Engineer Waterways Experiment Station, Vicksburg, MS.

Hoek and Bray 1981

Hoek, E. and Bray, J. W. 1981. *Rock Slope Engineering*, Revised Third Edition, Institute of Mining and Metallurgy, London, UK.

Justo 1991

Justo, J. L. 1991. "Test Fills and In Situ Tests," *Advances in Rockfill Structures*, NATO Advanced Sciences Institute (ASI) Series, Series E: Applied Sciences, Vol. 200, Edited by E. Maranha das Neves, Kluwer Academic Publishers, Boston, MA, pp. 153-194.

Lutton 1977

Lutton, R. J. 1977(Feb). "Design and Construction of Compacted Shale Embankments, Vol. 3, Slaking Indexes for Design," Report No. FHWA-RD-77-1, Federal Highway Administration, Washington, DC.

Lutton, Houston, and Warriner 1981

Lutton, R. J., Houston, B. J., and Warriner, J. B. 1981 (Sept). "Evaluation of Quality and Performance of Stone as Riprap or Armor," Technical Report GL-81-8, U.S. Army Engineer Waterways Experiment Station, Vicksburg, MS.

Murphy 1985

Murphy, W. L. 1985. "Geotechnical Descriptions of Rock and Rock Masses," Technical Report GL-85-3, U.S. Army Engineer Waterways Experiment Station, Vicksburg, MS.

NATO ASI Series 1991

North Atlantic Treaty Organization. 1991. *Advances in Rockfill Structures*, NATO Advanced Sciences Institute (ASI) Series, Series E: Applied Sciences, edited by

E. Maranha das Neves, Kluwer Academic Publishers, Boston, Ma.

Schmid 1967

Schmid, W. E. 1967. "Field Determination of Permeability by the Infiltration Test," Symposium on Permeability and Capillarity of Soils, ASTM Special Technical Publication 417, Philadelphia, PA, pp. 142-158.

Sherard and Cooke 1987

Sherard, J. L., and Cooke, J. B. 1987 (Oct). "Concrete-Face Rockfill Dam: I. Assessment," *Journal of Geotechnical Engineering*, Vol 113, No. 10, ASCE, pp 1096-1112.

Strohm, Bragg, and Ziegler 1978

Strohm, W. E., Bragg, G. H., and Ziegler, T. W. 1978 (Dec). "Design and Construction of Compacted Shale Embankments - Vol. 5., Technical Guidelines," Report No. FHWA-RD-78-141, Federal Highway Administration, Washington, DC.

Terzaghi and Peck 1948

Terzaghi, K., and Peck, R. B. 1948. *Soil Mechanics in Engineering Practice*, John Wiley and Sons, New York, NY, p. 48.

Torrey and Donaghe 1991

Torrey, V. H., and Donaghe, R. T. 1991 (Aug). "Compaction Characteristics of Earth-Rock Mixtures," Miscellaneous Paper GL-91-16, U.S. Army Engineer Waterways Experiment Station, Vicksburg, MS.

U.S. Committee on Large Dams 1988

U.S. Committee on Large Dams. 1988. "Construction Testing of Embankment Materials Containing Large Particles," Denver, CO.

U.S. Army Engineer District, Jacksonville 1983

U.S. Army Engineer District, Jacksonville. 1983 (June). "Cerrillos Dam, P&B Project, Design Memorandum No. 17, Dam and Spillway," Jacksonville, FL.

U.S. Army Engineer District, Los Angeles 1992

U.S. Army Engineer District, Los Angeles. 1992 (June). "Feature Design, Seven Oaks Dam, Embankment and Spillway, Foundation Investigation, Rock Test Excavation and Test Fills Report," Los Angeles, CA.

U.S. Army Engineer Waterways Experiment Station 1988

U.S. Army Engineer Waterways Experiment Station. 1988. "Test Data, Concrete Aggregates in the Continental

U.S. and Alaska,” Technical Memorandum 6-370, Vicksburg, MS.

U.S. Army Engineer Waterways Experiment Station 1993

U.S. Army Engineer Waterways Experiment Station. 1993. “Rock Testing Handbook,” Vicksburg, MS.

U.S. Department of the Interior, Bureau of Reclamation 1985

U.S. Department of the Interior, Bureau of Reclamation. 1985. *Earth Manual*, Second Edition, Denver, CO, p. 59.

U.S. Department of the Interior, Bureau of Reclamation 1989

U.S. Department of the Interior, Bureau of Reclamation. 1989. “Engineering Geology Field Manual,” Denver, CO.

Wegmann 1899

Wegmann, E. 1899. *The Design and Construction of Dams*, John Wiley and Sons, New York, NY.

Ziegler 1948

Ziegler, E. J. 1948. “Effect of Material Retained on the Number 4 Sieve on the Compaction Test of Soil,” *Proceedings*, Highway Research Board, Vol 28, pp. 409-414.

Appendix B Vibratory Roller Information

B-1. General

This appendix provides information and guidance concerning modern towed or self-propelled vibratory rollers. Although specifications written after the same fashion as 25 years ago are still usually adequate, evolution has taken place in the capability of the rollers such that specifications should now be written in a somewhat different manner in cognizance of the generally higher operational frequencies and how the roller applies compaction energy to the rock.

B-2. A Typical Former Specification

A vibratory roller specification of the form typically written in the past might have appeared as follows:

Vibratory rollers shall be equipped with a smooth steel compaction drum and shall be operated at a frequency of vibration during compaction operations between 1100 and 1500 vibrations per minute (vpm). Vibratory rollers may be either towed or self-propelled and shall have an unsprung drum weight that is a minimum of 60 percent of the rollers' total static weight. Towed rollers shall have at least 90 percent of their weight transmitted to the ground through the compaction drum when the roller is standing in a vertical position hitched to the towing vehicle. A 10-ton and 15-ton vibratory roller will be required. The 10-ton vibratory roller shall have a minimum static weight of 20,000 pounds, a minimum dynamic force of 40,000 pounds when operating at 1400 vpm, and an applied force of not less than 8,000 pounds per foot of compaction drum length. The 15-ton vibratory roller shall have a minimum static weight of 30,000 pounds, a minimum dynamic force of 50,000 pounds when operating at 1400 vpm, and an applied force of not less than 9,000 pounds per foot of compaction drum length. The level of amplitude and vibration frequency during compaction shall be maintained uniform throughout the embankment zone within which it is operating. Rollers shall be operated at speeds not to exceed 1.5 miles per hour. The equipment manufacturer shall furnish sufficient data, drawings, and compaction for verification of the above specifications. The character and efficiency of this equipment shall be subject to approval of the Contracting Officer.

B-3. Vibratory Roller Variables

The centrifugal force applied by a vibratory roller is a function of amplitude, unsprung drum weight, and vibrating frequency as follows:

$$\text{Centrifugal Force} = \frac{A \times W_u \times (VPM)^2}{35198} \quad (\text{B-1})$$

where:

A = Amplitude = The distance the drum lifts of the ground or surface

W_u = Unsprung drum weight = Weight of the drum and internal works only. Does not include frame, brackets, etc.

VPM = Vibrating Frequency = The number of times the drum lifts of the ground in a given minute

The constant 35198 is derived for dimensional consistency as:

$$C = \frac{g \times 60^2}{4\pi^2} \quad (\text{B-2})$$

where:

g = acceleration due to gravity = 385.6 inches per sec²

π = 3.14

Studies of impact spacing and force have resulted in the designation of 6 to 8 impacts per lineal foot of roller travel as minimum criteria for effective compaction. The number of roller impacts (lifting/falling of the drum) depends upon the vibrating frequency versus the speed of operation of the roller as follows:

$$\text{Impacts per foot} = \frac{VPM}{\text{speed of the roller, ft/min}} \quad (\text{B-3})$$

Table B-1 shows the impact spacing per foot for VPM versus roller speed.

Table B-1
Vibratory Rollers, Impact Spacing Per Foot

VPM	Rolling Speeds						
	1 mph	1.5 mph	2 mph	2.5 mph	3 mph	3.5 mph	4 mph
1200	13.6	9.1	6.8	5.5	4.5	3.9	3.4
1300	14.8	9.8	7.4	5.9	4.9	4.2	3.7
1400	15.9	10.6	7.9	6.4	5.3	4.5	4.0
1500	17.0	11.4	8.5	6.8	5.7	4.8	4.3
1600	18.2	12.1	9.0	7.2	6.0	5.2	4.5
1700	19.3	12.9	9.6	7.7	6.4	5.5	4.8
1800	20.4	13.6	10.2	8.2	6.8	5.8	5.1
1900	21.6	14.4	10.8	8.6	7.2	6.2	5.4
2000	22.7	15.2	11.4	9.1	7.6	6.5	5.7
2100	23.9	15.9	11.9	9.6	8.0	6.8	6.0
2200	25.0	16.7	12.5	10.0	8.3	7.1	6.2
2300	26.1	17.4	13.1	10.5	8.7	7.5	6.5
2400	27.3	18.2	13.6	10.9	9.1	7.8	6.8
2500	28.4	18.9	14.2	11.4	9.5	8.1	7.1

The total applied force (referred to as the dynamic force in the older specification of paragraph B-2) is the sum of the unsprung drum weight and the centrifugal force. Considering the 10-ton vibratory roller of paragraph B-2, the unsprung drum weight had to be at least 60 percent of 20,000 pounds or 12,000 pounds. Deducting that 12,000 pounds from the minimum required total applied force (minimum dynamic force) of 40,000 pounds at 1400 vpm results in a centrifugal force of 28,000 pounds at some amplitude, A. Using equation B-1, the required amplitude can be calculated as:

$$28,000 \text{ lb.} = \frac{A \times 28,000 \text{ lb.} \times 1400^2 \text{ vpm}}{35198} \quad (\text{B-4})$$

or:

$$A = 0.04 \text{ inches}$$

Using this amplitude, the range in centrifugal force allowed by the specification of paragraph B-2 by allowing vibration frequency to range between 1100 vpm and 1500 vpm can be calculated again from equation B-1 as:

$$CF_{1100} = \frac{(.04)(12,000)(1100^2)}{35198} = 16,500 \text{ lb.}$$

$$CF_{1500} = \frac{(.04)(12,000)(1500^2)}{35198} = 30,680 \text{ lb.}$$

and, adding the roller unsprung weight to each for total applied force, it is seen that the older specification version permitted that number to range from 28,500 pounds to 42,680 pounds which is a very wide range in applied compactive effort indeed. Since the applied force had to also be at least 8,000 pounds per foot of drum length, the 10-ton roller could vary in length from 3.6 ft long at 1100 vpm to 5.3 ft long at 1500 vpm. If that roller was operating at 1100 vpm at 1.5 mph, the impacts per lineal foot of travel would be $1100 \text{ vpm} / (88 \text{ ft/min} \times 1.5 \text{ mph}) = 8.3$. If the roller was operating at 1500 vpm, the impacts per foot would be $1500 \text{ vpm} / (88 \text{ ft/min} \times 1.5) = 11.4$. So, the older specification would generally suffice but leave considerable room in the compactive effort delivered.

B-4. A Recent Specification

The roller considerations for Seven Oaks Dam accommodated the modern roller capabilities such that the equipment specifications used there were as follows:

Vibratory rollers used for compacting filter, rock transition, rockfill, alluvial transition, shell, and rock toe material shall be equipped with a smooth steel compaction drum and may be either towed or self-propelled. Towed rollers shall have at least 90 percent of their weight transmitted to the ground through the compaction drum when the roller is standing in a level position hitched to the towing vehicle. A 10-ton and 15-ton vibratory roller will be required. The 10-ton vibratory roller shall have a minimum static weight of 20,000 pounds and be capable of delivering a total applied force of not less than 8,000 pounds per foot of drum width, but not to exceed 9,000 pounds per foot of drum width. The 15-ton vibratory roller shall have a minimum static weight of

30,000 pounds and shall be capable of delivering a total applied force of not less than 10,000 pounds per foot of drum width. The total applied force shall be the sum of the centrifugal force and the drum module weight. The level of amplitude and vibration frequency during compaction shall be maintained uniform throughout the embankment zone within which it is operating. Rollers shall be operated at speeds which will result in a minimum of 10 impacts per foot of roller travel. The equipment manufacturer shall furnish sufficient data, drawings, and compaction for verification of the above specifications. The character and efficiency of this equipment shall be subject to the approval of the Contracting Officer.

It is apparent that this specification establishes the compactive effort as a minimum value and allows the maximum speed of operation for cost efficiency in fill operations.

Appendix C List of Symbols

A	Amplitude of a vibratory roller
e	Void ratio
c	Percent by weight of coarser fraction of the total material, expressed as a decimal, (1-f)
C	A dimensionless constant in calculating the centrifugal force of a vibratory roller = 35198
CF_{1000}	Vibratory roller centrifugal force operating at 1000 vpm
CF_{1500}	Vibratory roller centrifugal force operating at 1500 vpm
f	Percent by weight of finer fraction of the total material, expressed as a decimal, (1-c)
k	Coefficient of permeability
g	Acceleration due to gravity
G_m	Bulk specific gravity
G_s	Grain specific gravity or specific gravity of solids
H	Diamond core drill size, nominal 7.6 cm (3 in.)
H_w	Applied hydraulic head in the USBR constant-head permeability test
h_0	Initial depth of water in the open-pit permeability test
h	Depth of water in open-pit permeability test at time $t = \Delta t$
h_1	Height of water above tip of the standpipe at time $t = t_1$ in the Schmid falling-head test
h_2	Height of water above the tip of the standpipe at time $t = t_2$ in the Schmid falling-head test
n	porosity
n_r	porosity of the rock particle
N	Diamond core drill size, nominal 5.1 cm (2 in.)
Q	A rock classification system for engineering purposes
Q_d	Flow rate in a constant-head permeability test
RMR	A rock classification system for engineering purposes
RQD	Rock Quality Determinator

EM 1110-2-2301
30 Sep 94

r_0	Inside radius of the standpipe in the standpipe permeability test
S	Degree of saturation
S_i	Initial degree of saturation of the compacted fill
S_w	Wetted degree of saturation of the compacted fill during the permeability test
vpm	Vibrations per minute
w	Water content
W_u	The unsprung weight of a vibratory roller drum module
Δh	Change in head over the time interval Δt in the falling-head permeability test
ΔS	Change in degree of saturation from the as-compacted condition to a wetted condition
Δt	Elapsed time in the falling-head permeability test
γ_d	Dry density
γ_f	Dry density of the finer fraction
γ_m	Bulk density
γ_t	Dry density of the total material
γ_w	Unit weight of water
λ	Mean number of discontinuities per meter in a rock mass
π	The constant Pi = 3.1416